

If you experience problems accessing any portion of our files,
please contact CMS at HOS@cms.hhs.gov.



SAMPLE
2017 COHORT 20
MEDICARE
ADVANTAGE
ORGANIZATION

BASELINE
REPORT

Medicare Health

Outcomes Survey

Centers
for Medicare
& Medicaid
Services

Health
Services
Advisory
Group



DEPARTMENT OF HEALTH & HUMAN SERVICES
Centers for Medicare & Medicaid Services
7500 Security Boulevard
Baltimore, Maryland 21244-1850



CENTER FOR MEDICARE

May 2018

Medicare Advantage Organizations,

The Centers for Medicare & Medicaid Services (CMS) is pleased to provide you with your Medicare Advantage Organization's (MAO) baseline results for *2017 Cohort 20* of the Medicare Health Outcomes Survey (HOS). The *2017 Cohort 20 Baseline* Report includes results from the Medicare HOS Version 3.0. CMS encourages MAOs to examine their results for use in quality improvement activities.

The HOS Baseline Report is distributed to help MAOs identify opportunities to improve their HOS results. Information on the HOS measures used in the Medicare Star Ratings, as well as additional resources to assist MAOs in their quality improvement efforts, are included in the report. The information indicates where beneficiaries are doing poorly, and identifies subgroups where the MAO performance differs from the national average for a specific measure.

For more program information, you may submit inquiries to hos@HCQIS.org, or contact Health Services Advisory Group (HSAG) through the HOS Information and Technical Support telephone line at (888) 880-0077, and you may visit the CMS HOS website at <https://www.cms.gov/Research-Statistics-Data-and-Systems/Research/HOS/index.html>.

Sincerely,

Elizabeth Goldstein, PhD
Director
Division of Consumer Assessment & Plan Performance

Medicare Health Outcomes Survey

Sample MAO Report

The following is a **sample** version of the *Cohort 20 Baseline* Report made available to all Medicare Advantage Organizations (MAOs) participating in the *2017 Cohort 20 Baseline* Medicare Health Outcomes Survey.

The figures, tables, and text in this document contain example MAO and state level data; however, all references to the *HOS Total* reflect **actual** data.

The Medicare HOS Information and Technical Support Telephone Line (1-888-880-0077), and Email Address (hos@HCQIS.org), are available to provide assistance with report questions and interpretation. A full description of the HOS program may be found at www.HOSonline.org.

Table of Contents

Executive Summary	1
Summary Score Trends for MAO HXXXXA.....	3
NCQA HEDIS Measure Trends for MAO HXXXXA	4
Health Status Trends for MAO HXXXXA	5
Reader’s Guide.....	8
Technical Assistance	8
How to Use the Information Contained in this Report.....	8
Need More Help?	10
What’s New in the HOS	11
Implementation of HOS 3.0	11
HOS Website Enhancements	11
Semiannual HOS Newsletters	11
CMS Approved Survey Vendors.....	11
Frequently Asked Questions (FAQs)	12
Self-Paced Training Webinars.....	12
Veterans RAND 12-Item Health Survey (VR-12) Website	12
National Cancer Institute (NCI) SEER-MHOS Linked Data Sets	13
HOS and the Star Ratings.....	14
Medicare Star Ratings	14
2018 and 2019 Medicare Part C Star Ratings	15
MAO Resources for Best Practices and the Star Ratings.....	16
2017 Cohort 20 Baseline Results	17
Distribution of the Sample and Response Rates	17
Demographics.....	19
Physical and Mental Component Summary Scores	20
General Health and Comparative Health	21
Depression.....	24
Pain.....	25
Chronic Medical Conditions	27
Activities of Daily Living	29

Healthy Days Measures.....	33
Body Mass Index.....	35
Sleep Measures.....	37
Health Status by Baseline Demographic Groups for MAO HXXXXA.....	38
2017 NCQA HEDIS Measures.....	46
Management of Urinary Incontinence in Older Adults.....	47
Physical Activity in Older Adults	50
Fall Risk Management	53
Osteoporosis Testing in Older Women	55
Appendix 1	57
Program Background.....	57
2017 Medicare Advantage Organization Participation	57
2017 Methodology and Design	58
Appendix 2	64
2017 Cohort 20 Baseline Frequencies of Survey Fields for MAO HXXXXA.....	64
Appendix 3	77
References	79

Executive Summary

This Medicare Health Outcomes Survey (HOS) Baseline Report presents aggregate results for Medicare Advantage Organizations (MAOs), as well as specific results for MAO HXXXXA based on data from the Medicare HOS *2017 Cohort 20 Baseline Survey*. The *2017 Cohort 20 Baseline* survey was fielded from April through June of 2017 and included a random sample of 545,210 beneficiaries, consisting of both the aged and disabled, from 466 MAOs. The number of beneficiaries represents a 1.5% increase from the 537,259 beneficiaries sampled from 459 MAOs that participated in the HOS *2016 Cohort 19 Baseline Survey*.

Figure 1 on the following page describes the distribution of the national HOS sample and the response rate for the HOS Total. Of the 545,210 beneficiaries originally sampled, 12,086 were determined to be ineligible during the survey administration. Ineligible beneficiaries met one of the following criteria: deceased; not enrolled in the MAO; had an incorrect address and phone number; had a language barrier; or were removed from the sample due to age less than 18 years. The exclusion of the ineligible beneficiaries from the total sample yields the *Cohort 20 Baseline* eligible sample of 533,124.

Of the total eligible sample, 229,330 (43.0%) completed the survey. For the purposes of this report, a completed survey is defined as one that could be used to calculate a physical component summary (PCS) score or mental component summary (MCS) score. Of those eligible and completing the survey, 190,587 were seniors (≥ 65 years) who comprised the final *2017 Cohort 20 Baseline* analytic sample. Respondents to this baseline cohort will be resurveyed for the *Cohort 20 Follow Up Survey* in the Spring/Summer of 2019. Results from the combined baseline and follow up surveys will be available in the *2017-2019 Cohort 20 Performance Measurement Report* that is planned for distribution in the Summer of 2020.

The baseline results are intended to help MAOs identify areas for potential improvement and to identify areas where they are doing well. On the following pages of this Executive Summary, the reader will find MAO, state, and national results across key indicators of beneficiary health status. For instance, the baseline PCS and MCS scores are provided along with the National Committee for Quality Assurance (NCQA) Healthcare Effectiveness Data and Information Set (HEDIS[®])¹ rates. In addition, trend results over three baseline cohorts are depicted in the MAO report for the summary scores and over three rounds of data for the HEDIS measures. Finally, this Executive Summary provides information about general and comparative health, healthy days, and obesity measures. More detailed information about the results is found in the Baseline Results and NCQA HEDIS Measures sections of the report.

For MAOs with a small number of respondents, caution should be exercised when drawing conclusions from the results throughout the HOS Baseline Report, as the sample size may be insufficient to allow meaningful interpretation. Note that the statistics for State and Region in any figures or tables are *not applicable* (NA) for Regional Preferred Provider Organizations (RPPO) and Private Fee-for-Service (PFSS) plans. For reporting purposes, these types of plans are not included in any specific State or Region numbers; however, they are included in the HOS Total number.

Figure 1: 2017 Cohort 20 Baseline Distribution of the Sample and Response Rates for MAO HXXXXA and HOS Total

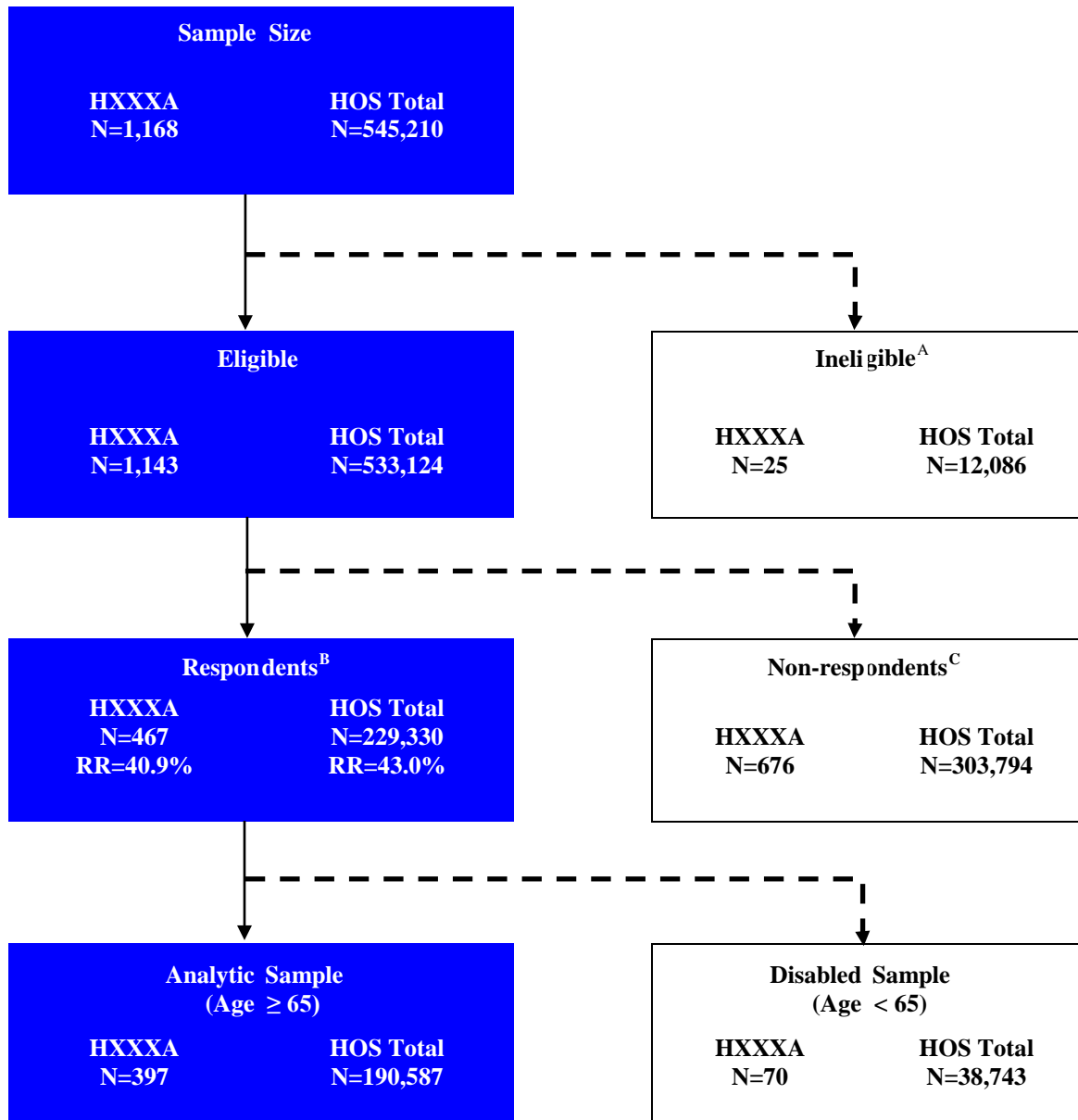

^A Deceased, not enrolled in MAO, incorrect address and phone, language barrier, or removed from sample due to age less than 18 years.

^B Response Rate = [(Respondents/Eligible Sample) x 100%].

^C Surveys for which PCS and MCS scores cannot be calculated.

Summary Score Trends for MAO HXXXXA

Physical and Mental Health Scores

The primary physical and mental health status measures for the HOS are the PCS and MCS scores.^D These baseline scores (when combined with the two-year follow up scores and death status) are important components of the HOS results used for the Medicare Star Ratings for all MAOs.^E In general, functional health status, as measured by the PCS score, is expected to decline over time in older age groups, while mental health status, as measured by the MCS score, may decline at a slower rate. The baseline PCS and MCS scores are case-mix adjusted to allow for equitable comparisons across all MAOs.^F For the 2017 HOS national sample, a mean PCS score of 39.1 and a mean MCS score of 52.8 were calculated.

At the national level:

- The mean adjusted PCS score was highest for the 65-69 year age group with a mean PCS of 41.5. As expected, a steady decline with increasing age was pronounced for the physical health measure, with a mean PCS score of 40.1 for 70-74 year olds, 38.3 for 75-79 year olds, and 36.5 for 80-84 year olds. The lowest mean PCS score of 34.1 was calculated for those 85 or older.
- The mean adjusted MCS score was more consistent across age groups, with a mean score of 52.8 for 65-69 year olds, 53.2 for 70-74 year olds, and 53.1 for 75-79 year olds. The mean MCS score was slightly lower in the 80-84 year age group (52.7) and lowest among those 85 or older (51.9).

Table 1 presents the mean unadjusted and adjusted PCS and MCS scores for your MAO, the state, and HOS Total. The results presented in the table are from the *Cohort 20 Baseline* analytic sample. Additionally, in Appendix 3, Table 42 provides the mean unadjusted and adjusted PCS and MCS scores for all MAOs in your state, as well as the state and HOS Total. For detailed information about the scores, please refer to the Baseline Results section. Note that the baseline information summarized in this table is not suitable for MAO level comparisons, and should not be used for public release or marketing purposes.

Table 1: 2017 Cohort 20 Baseline Mean Unadjusted and Adjusted PCS and MCS Scores for MAO HXXXXA, STXXXX and HOS Total[†]

	Unadjusted PCS Score (SD)	Adjusted PCS Score (SD)	Unadjusted MCS Score (SD)	Adjusted MCS Score (SD)
HXXXXA	39.2 (12.2)	39.2 (6.9)	53.0 (10.8)	52.8 (5.5)
StateXX	39.0 (12.5)	39.1 (7.1)	53.0 (10.9)	53.0 (5.7)
HOS Total	39.1 (12.6)	39.1 (7.1)	52.8 (11.0)	52.8 (5.7)

[†]See Appendix 3, Table 42 results for all MAOs in the state.

^D See Appendix 1 for more information about how PCS and MCS scores are derived from the HOS measure.

^E For additional information, refer to the HOS and the Star Ratings section of this report.

^F Case-mix adjustment is a statistical technique that controls for differences in demographics, socioeconomic characteristics, chronic medical conditions, and HOS study design variables.

Table 2 shows the trends in mean unadjusted and adjusted PCS and MCS scores for MAO HXXXXA over the most recent baseline cohorts, where available. The direction of these trends reflects the overall physical and mental health status of your MAO beneficiaries over time. While the demographics of your beneficiaries may change, negative trends indicate poorer health status across those questions comprising the PCS and MCS scores.

Table 2: Trends in Mean Unadjusted and Adjusted PCS and MCS Scores over Three Baseline Cohorts for MAO HXXXXA

	Unadjusted PCS Score (SD)	Adjusted PCS Score (SD)	Unadjusted MCS Score (SD)	Adjusted MCS Score (SD)
2017 Cohort 20	39.2 (12.2)	39.2 (6.9)	53.0 (10.8)	52.8 (5.5)
2016 Cohort 19	38.7 (12.4)	39.4 (7.1)	53.4 (10.4)	53.3 (5.4)
2015 Cohort 18	40.8 (12.2)	40.2 (6.7)	52.7 (11.2)	53.6 (5.4)

NA in a row indicates that the MAO did not have results for that cohort.

NCQA HEDIS Measure Trends for MAO HXXXXA

Four 2017 NCQA HEDIS Effectiveness of Care measures are collected for HOS seniors. Components of these HEDIS measures will be incorporated into the 2019 Medicare Star Ratings, which will be used as the basis for quality bonus payments in 2020. For the 2017 NCQA HEDIS measures, members with evidence from CMS administrative records of a hospice start date or hospice enrollment are excluded from the HEDIS measure calculations.

Table 3 depicts the mean rates for the four HEDIS measures for your MAO, the state, CMS Region, and the HOS Total. These results are from the combined Cohort 20 Baseline and Cohort 18 Follow Up data collected in 2017; i.e., a round of data. A HEDIS rate of *not applicable* (NA) indicates the rate was not calculated; see the NCQA HEDIS Measures section for more information. Additionally, in Appendix 3, Table 43 provides the HEDIS measures for all MAOs in your state, CMS Region, and HOS Total. Note that state and region results are *not applicable* (NA) for RPP0 and PFFS plans.

Table 3: 2017 NCQA HEDIS Rates for MAO HXXXXA, STXXXX, CMS Region XX and HOS Total[†]

	MUI Discuss Rate	MUI Treat Rate*	MUI Impact Rate	PAO Discuss Rate	PAO Advise Rate*	FRM Discuss Rate	FRM Manage Rate*	OTO Testing Rate
HXXXXA	58.59%	45.45%	13.86%	58.67%	51.38%	33.79%	56.58%	78.42%
StateXX	59.18%	44.99%	14.92%	56.57%	50.87%	34.87%	58.12%	76.33%
CMS Region XX	58.68%	44.84%	14.79%	57.08%	51.45%	34.59%	57.50%	76.62%
HOS Total	59.33%	45.44%	15.88%	55.70%	51.74%	36.50%	58.62%	74.24%

* Measures incorporated into the 2019 Medicare Star Ratings include the MAO 2017 Improving Bladder Control (MUI Treat Rate), Monitoring Physical Activity (PAO Advise Rate) and Reducing the Risk of Falling (FRM Manage Rate).

[†]See Appendix 3, Table 43 results for all MAOs in the state.

The results in Table 4 show the trends in HEDIS results for your MAO over the current and previous two rounds, where available. Consider the direction of these trends when implementing preventative health interventions and care management efforts to improve HEDIS results. If the trend is in a negative direction across any of these HEDIS results, your MAO may consider allocating resources to address the causes of the decline and monitor future performance.

Table 4: Trends in NCQA HEDIS Rates over Three Rounds of Data for MAO HXXXXA

	MUI Discuss Rate	MUI Treat Rate*	MUI Impact Rate	PAO Discuss Rate	PAO Advise Rate*	FRM Discuss Rate	FRM Manage Rate*	OTO Testing Rate
2017 Round 20	58.59%	45.45%	13.86%	58.67%	51.38%	33.79%	56.58%	78.42%
2016 Round 19	56.14%	44.12%	14.29%	55.87%	50.40%	31.93%	56.93%	77.06%
2015 Round 18	58.90%	46.63%	14.77%	56.00%	50.59%	32.81%	56.59%	76.81%

* Measures incorporated into the 2019 Medicare Star Ratings include the MAO 2017 Improving Bladder Control (MUI Treat Rate), Monitoring Physical Activity (PAO Advise Rate), and Reducing the Risk of Falling (FRM Manage Rate). NA in a row indicates that the MAO did not have results for that round.

Health Status Trends for MAO HXXXXA

The *2017 Cohort 20 Baseline Report* includes results for the Medicare population across different indicators of health: general health, comparative physical health, and comparative mental health. The indicator of general self-rated health is used in the calculation of PCS and MCS scores. The comparative health indicators are considered foundational measures of health-related quality of life (HRQOL), and are tracked by the Federal Government as part of the national Healthy People Health-Related Quality of Life 2020 Goals.²

Table 5 describes results for the general and comparative health status of beneficiaries in your MAO, the state, and HOS Total. Beneficiaries who indicated that their general health was “Fair” or “Poor,” or that their physical or mental health was “Slightly Worse” or “Much Worse” compared to one year ago may assume greater risk for mortality.³ Thus, self-rated health status questions are sentinel indicators of underlying health problems that require effective identification and treatment.

Table 5: 2017 Cohort 20 Baseline Self-Rated General and Comparative Health Status for MAO HXXXXA, STXXXX and HOS Total

	General Health		Comparative Physical Health		Comparative Mental Health	
	Excellent to Good*	Fair or Poor	Much Better to About the Same*	Slightly Worse or Much Worse	Much Better to About the Same*	Slightly Worse or Much Worse
HXXXXA	71.2%	28.8%	69.6%	30.4%	86.1%	13.9%
StateXX	71.6%	28.4%	71.7%	28.3%	88.0%	12.0%
HOS Total	71.1%	28.9%	73.3%	26.7%	87.0%	13.0%

* Categories for general health included “Excellent,” “Very good,” or “Good.” Categories for comparative health included “Much better,” “Slightly better,” or “About the same.”

Table 6 shows the results of general and comparative health status for your MAO over the current and previous two baseline cohorts, where available. These trends may change over time based on the composition of your MAO beneficiary population. Nevertheless, self-rated health status questions may help your MAO anticipate future health outcomes and health care utilization of your beneficiary population. Negative trends indicate a decline in perceived health status that may be influenced by current or future disease or injury outcomes.

Table 6: Trends in Self-Rated General and Comparative Health Status Over Three Baseline Cohorts for MAO HXXXXA

	General Health		Comparative Physical Health		Comparative Mental Health	
	Excellent to Good*	Fair or Poor	Much Better to About the Same*	Slightly Worse or Much Worse	Much Better to About the Same*	Slightly Worse or Much Worse
2017 Cohort 20	71.2%	28.8%	69.6%	30.4%	86.1%	13.9%
2016 Cohort 19	71.5%	28.5%	74.3%	25.7%	88.2%	11.8%
2015 Cohort 18	75.2%	24.8%	72.1%	27.9%	86.0%	14.0%

* Categories for general health included “Excellent,” “Very good,” or “Good.” Categories for comparative health included “Much better,” “Slightly better,” or “About the same.”

NA in a row indicates that the MAO did not have results for that cohort.

Table 7 illustrates the percentage of beneficiaries with 14 or more days of poor physical health, poor mental health, and days of activity limitations in the past 30 days for your MAO, the state, and HOS Total. In general, 14 or more days of poor health or activity limitations are considered indicative of poor well-being.⁴ These HRQOL measures help identify vulnerable sub-populations with the greatest risk for disease or injury.

Table 7: 2017 Cohort 20 Baseline Healthy Days Measures for MAO HXXXXA, STXXXX and HOS Total

	14 or More Days of Poor Physical Health	14 or More Days of Poor Mental Health	14 or More Days of Activity Limitations
HXXXXA	21.9%	12.2%	17.3%
StateXX	21.3%	13.1%	15.8%
HOS Total	21.4%	12.4%	15.2%

Table 8 below describes the Healthy Days results for your MAO over the current and previous two baseline cohorts, where available. Your MAO may consider using these HRQOL indicators as tools to evaluate the distal or environmental factors that influence health (i.e., access to care and social support).⁴ The health status of your beneficiaries may improve as these broader influences on health are incorporated into quality improvement efforts.

Table 8: Trends in Healthy Days Measures over Three Baseline Cohorts for MAO HXXXXA

	14 or More Days of Poor Physical Health	14 or More Days of Poor Mental Health	14 or More Days of Activity Limitations
2017 Cohort 20	21.9%	12.2%	17.3%
2016 Cohort 19	22.4%	9.5%	13.6%
2015 Cohort 18	19.0%	12.2%	12.4%

NA in a row indicates that the MAO did not have results for that cohort.

Table 9 depicts the distribution of Body Mass Index (BMI)^{G,H} for beneficiaries in your MAO, the state, and HOS Total. Healthy People 2020 set a target of at least 33% of adults to be at a normal body weight.⁵ Underweight and obesity are threats to the health status of older adults. Underweight in the elderly is usually caused by disease and acts as an effect modifier on the relationship between aging and muscle loss. Rapid unintentional weight loss hastens the muscle loss usually associated with increasing age.⁶ On the other hand, obesity increases the risk for chronic diseases such as hypertension and type-2 diabetes. According to an analysis of obesity prevalence in MAOs, beneficiaries who were obese accounted for significantly poorer health outcomes and higher utilization of health care services when compared to beneficiaries who were overweight.⁷ Helping beneficiaries maintain a healthy weight may increase their quality of life and reduce health care expenditures.

Table 9: 2017 Cohort 20 Baseline BMI Measures for MAO HXXXXA, STXXXX and HOS Total

	Underweight (BMI <18.5)	Normal Weight (BMI 18.5 to 24.99)	Overweight (BMI 25 to 29.99)	Obese (BMI ≥30)
HXXXXA	1.8%	26.7%	37.5%	34.0%
StateXX	2.1%	27.9%	37.7%	32.3%
HOS Total	2.1%	29.0%	37.0%	31.9%

Table 10 illustrates the distribution of BMI categories for your MAO over the current and previous two baseline cohorts, where available. National trends show increasing rates of obesity across all the United States.⁸ Although the composition of your MAO beneficiaries may change from year to year, these trend data allow your MAO to monitor the direction of the prevalence of obesity within your beneficiary population. Successful efforts to move beneficiaries into the normal weight category may reduce the incidence of negative health outcomes directly linked to either underweight or obesity.

Table 10: Trends in BMI Measures over Three Baseline Cohorts for MAO HXXXXA

	Underweight (BMI <18.5)	Normal Weight (BMI 18.5 to 24.99)	Overweight (BMI 25 to 29.99)	Obese (BMI ≥30)
2017 Cohort 20	1.8%	26.7%	37.5%	34.0%
2016 Cohort 19	2.5%	27.6%	35.9%	34.0%
2015 Cohort 18	1.5%	27.6%	42.4%	28.6%

NA in a row indicates that the MAO did not have results for that cohort.

^G BMI is calculated as: $BMI = [\text{weight in pounds} / (\text{height in inches})^2] \times 703$, which uses the height and weight to produce the standard measure of kg/m^2 units.

^H BMI categories were modified beginning with this report. Underweight was changed from “<20” to “<18.5” and normal weight was changed from “20 to 24.99” to “18.5 to 24.99.” Trend tables also reflect the revised calculation for prior years and will differ from the categories reported in the original baseline reports.

Reader's Guide

The Reader's Guide is provided to assist Medicare Advantage Organizations (MAOs) use their Medicare Health Outcomes Survey (HOS) Baseline Report information effectively. This section will guide the reader to identify key topics, such as the CMS Medicare Star Ratings, and answer general questions about the reports and data. For further assistance, please refer to the Technical Assistance information below. Additionally, the What's New section in this report has information about new website content, webinars, and HOS program updates.

Technical Assistance

The Medicare HOS Information and Technical Support Telephone Line (1-888-880-0077) and Email Address (hos@HCQIS.org) are available to provide assistance with report questions and interpretation. Additionally, the CMS HOS website provides general information on the program (<https://www.cms.gov/Research-Statistics-Data-and-Systems/Research/HOS/index.html>). A full description of the HOS program is available at www.HOSonline.org.

How to Use the Information Contained in this Report

The reports are designed to assist MAOs in identifying opportunities to reduce health disparities and explore potential programmatic interventions aimed at maintaining or improving the overall health of their Medicare population. Health status indicators are displayed within demographic groups to emphasize where beneficiaries are doing poorly. This additional detail is included to help plans identify potential areas for further investigation.

What information can I find in this Baseline Report?

A random sample of Medicare beneficiaries is drawn from each participating MAO and surveyed every spring (i.e., the HOS questionnaire is administered to a different baseline cohort, or group, each year). The results for key health indicators derived from the HOS are provided in the report. Please refer to the description of each report section below and to the Table of Contents for the specific section pages.

- **Executive Summary:** highlights the sample distribution and response rates. MAO, state, and national results across key indicators, including physical and mental health summary measures, Healthcare Effectiveness Data and Information Set (HEDIS[®])¹ Effectiveness of Care measures, and other general and comparative health indicators are provided. Trend tables for select measures over the most recent three cohorts are also provided in the MAO reports.
- **What's New in the HOS:** introduces new and updated HOS program information, self-paced training webinars, and website resources for MAOs and other data users.
- **HOS and the Star Ratings:** discusses the HOS measures that are currently used by CMS for the Medicare Star Ratings. Two of the HOS measures are reported in the HOS Performance Measurement Report: *Improving or Maintaining Physical Health* and *Improving or Maintaining Mental Health*. The three measures that are reported in the HOS Baseline Report include the following: *Improving Bladder Control*, *Monitoring*

Physical Activity, and *Reducing the Risk of Falling*. Beginning with the 2012 Medicare Star Ratings, the *Osteoporosis Testing in Older Women* measure was moved to the display measures on the CMS website and is not part of the Star Ratings.

- **2017 Cohort 20 Baseline Results:** provides results for the MAO and national HOS Total analytic samples including a summary of the number of participating beneficiaries, the response rates, and demographic information. Detailed results are also provided for key health indicators derived from the HOS, such as physical component summary (PCS) and mental component summary (MCS) scores, General Health and Comparative Health, Depression, Pain, Chronic Medical Conditions, Activities of Daily Living (ADLs), Healthy Days Measures, Body Mass Index (BMI) and Sleep Measures. In this section, demographic tables compare the MAO to the HOS Total, where estimates highlighted in **red** indicate groups in the MAO that are worse off than the overall HOS sample.
- **2017 NCQA HEDIS Measures:** includes information about the following HEDIS Effectiveness of Care measures: *Management of Urinary Incontinence in Older Adults*, *Physical Activity in Older Adults*, *Fall Risk Management*, and *Osteoporosis Testing in Older Women*. Data values are provided to the second decimal place for HEDIS rates since specific elements of these measures are used in the Medicare Star Ratings.
- **Appendix 1:** provides a description of the program, sampling methodology, survey administration, and the HOS 3.0 instrument. Information is included about the questions used in the calculation of PCS and MCS scores, and case-mix adjustment of the scores.
- **Appendix 2:** displays graphs for selected survey questions. Please note that the percentages in the graphs may not add to 100% due to rounding.
- **Appendix 3:** provides two additional tables that report PCS and MCS scores, and HEDIS rates for all MAOs in the state, the state, and HOS Total.
- **References:** lists journal articles, technical reports, and website references that are provided throughout the report.

Where can I find additional HOS Program information, such as sampling methodology, and timelines for the reporting and data distribution?

An overview of the HOS Program, the sampling schedule, and program timelines, are available on the Program page of the HOS website at <http://hosonline.org/en/program-overview/>. A table of MAO report and data distribution is provided on the Data page of the website.

Are HOS measures part of the CMS Medicare Star Ratings?

HOS measures are included in the Medicare Star Ratings, which CMS developed to provide consumer information about MAOs and to reward high-performing health plans. CMS displays MAO information in the Medicare Plan Finder (MPF) tool on the <http://www.medicare.gov/find-a-plan> website and awards quality bonus payments to high-performing health plans. For information about the Star Ratings, refer to the HOS and the Star Ratings section in this report.

How are the Baseline Reports distributed?

All reports are distributed electronically to participating MAOs through the CMS Health Plan Management System (HPMS), which requires an HPMS User ID. The HOS Baseline Reports are

distributed in a ZIP file one year after data collection. Downloads include the PDF report and the summary-level data in a CSV file that can be opened in Excel and contains contract-level survey responses, demographic data, and the HEDIS rates from the Medicare Star Ratings. Please visit the CMS site for information on how to establish access to HPMS: <https://www.cms.gov/Research-Statistics-Data-and-Systems/Computer-Data-and-Systems/HPMS/UserIDProcess.html>. If assistance is required regarding HPMS access, contact CMS at hpms_access@cms.hhs.gov.

When will MAOs receive beneficiary level data for *Cohort 20 Baseline*?

The merged baseline and follow up beneficiary level data will be distributed to the MAOs in the Fall of 2020, after completion of the 2019 follow up survey and the release of the *2017-2019 Cohort 20 Performance Measurement Report* in 2020. MAOs are notified via the HPMS about the availability of their merged data and how to request it.

Where can I find overall survey results information for earlier HOS cohorts that can be compared to the information in this report?

The Survey Results section at <http://hosonline.org/en/survey-instrument/survey-results/> on the HOS website provides a table depicting general status information at the national HOS level, including sample sizes, completed surveys, and response rates, for the baseline and follow up cohorts administered and reported to date. Participating MAOs may also access their earlier reports through the HPMS.

Need More Help?

- MAOs are encouraged to contact the HOS Technical Support Team at Health Services Advisory Group at hos@HCQIS.org with questions.
- Additional information about peer-reviewed articles, technical reports, and manuals related to the HOS is available on the Resources page of the HOS website (www.HOSonline.org). Consult the Home page for a listing of new reports and general updates.
- A glossary consisting of definitions relevant to the Medicare HOS may be accessed from the “Glossary” link at the bottom of site webpages.
- The 2017 HOS 3.0 questionnaire may be downloaded from the Survey page of the HOS website. In addition, the HOS questionnaire is found in the NCQA HEDIS 2017, Volume 6 Specifications for the Medicare Health Outcomes Survey Manual on the HOS website.⁹ The manual is available online for download from the Survey Administration section under the Program page. Copies of other HEDIS Volume 6 publications may also be purchased by calling the NCQA Customer Support Telephone Line at 1-888-275-7585 or via NCQA’s Publications Center (<http://www.ncqa.org/publications-products>).

What's New in the HOS

Implementation of HOS 3.0

The 2017 survey administration used the HOS 3.0 that was implemented in 2015. Like the previous versions (HOS 2.0 and 2.5), the HOS 3.0 uses the Veterans RAND 12-Item Health Survey (VR-12) as the core physical and mental health outcomes measures, and the four HEDIS Effectiveness of Care measures are the *Management of Urinary Incontinence in Older Adults*, *Physical Activity in Older Adults*, *Fall Risk Management*, and *Osteoporosis Testing in Older Women*. Modifications from the HOS 2.5 included: changes to questions about leakage of urine, osteoporosis testing in older women, sleep duration and quality, and primary language spoken in the home. In 2015, a formatting change in the survey uses a two column layout for each page. The 2017 HOS 3.0 is available on the Survey page of the HOS website (www.HOSonline.org).

HOS Website Enhancements

To improve access, usability, and function, the HOS website has been migrated to an improved web content management platform with site design and navigability enhancements.

The HOS website is a resource that provides:

- Historical overview of the project
- Updates on project activities
- Reports of ongoing research efforts
- Access to public use files and supporting documentation
- Clearinghouse of electronic information about journal articles, bibliographies, and technical reports relating to the HOS
- Links to project partners

Semiannual HOS Newsletters

The HOS Newsletters contain information about HOS products, services, and timelines; program updates; self-paced training programs; and other relevant topics, such as sharing of best practices. HOS Newsletters are circulated semiannually via email, in winter and summer, to MAO contacts and users of the HOS technical support, and are posted on the HOS website. If you would like to receive the HOS Newsletters, contact the HOS Information and Technical Support team at hos@HCQIS.org.

CMS Approved Survey Vendors

The Survey Vendors section under the Program page on the HOS website provides a list of CMS approved survey vendors. There were six survey vendors approved to administer the HOS in 2017.

Frequently Asked Questions (FAQs)

The “FAQs” link at the bottom of site webpages (www.HOSonline.org) provides answers to frequently asked questions about the Medicare HOS. Examples are questions about where to find the current survey administration documents and HOS questionnaires, how MAOs may obtain their reports and data, and where to find quality improvement ideas. Information is also provided about the types of files available for researchers and how to obtain the files.

Self-Paced Training Webinars

A series of basic to advanced self-paced training webinars are available on the HOS website. The webinars run approximately 30 minutes in length and may be accessed at any time at the convenience of the user. To access the webinars, go to the Trainings section under the Resources page on the HOS website.

- **Introduction to the Medicare Health Outcomes Survey (HOS):** a basic training session appropriate for MAOs that are new to the HOS or those wanting to obtain an overview of the HOS. In addition, the introductory training program provides some practical guidance about how to obtain HOS reports and data.
- **Getting the Most from Your Medicare Health Outcomes Survey (HOS) Baseline Report:** an intermediate training session that builds on the information from the basic tutorial described above. The training discusses maximizing the use of the HOS Baseline Report to provide information on the health of beneficiaries and incorporating chronic care improvement programs (CCIPs) in quality improvement activities.
- **Using Your Medicare Health Outcomes Survey (HOS) Data:** an intermediate training session assisting MAOs with using their HOS data to identify priorities and assess the impact of interventions. It also demonstrates the advantages of linking HOS data with your own MAO data.
- **Understanding the Medicare Health Outcomes Survey (HOS) Performance Results Used in the MA Plan Ratings:** an advanced training session describing the methodology used in calculating the Performance Measurement Results. The tutorial discusses the primary health outcomes collected from the survey, the PCS and MCS scores, and how they are used to describe changes in the functional status of MAO beneficiaries over a two-year period. It also discusses how the HOS results are used in the MA Plan Ratings, also called the Medicare Star Ratings.

Veterans RAND 12-Item Health Survey (VR-12) Website

Information about the VR-36, VR-12, and VR-6D instruments is available on the Boston University School of Public Health website. The website offers details on development, applications, and references for the VR-12, which is the core health outcomes measure in the Medicare HOS and HOS-M. For information about the instruments and to request permission to use the documentation and scoring algorithms, go to: <http://www.bu.edu/sph/research/research-landing-page/vr-36-vr-12-and-vr-6d>.

National Cancer Institute (NCI) SEER-MHOS Linked Data Sets

The Surveillance, Epidemiology, and End Results (SEER) and the Medicare Health Outcomes Survey (MHOS) linked data sets are available for researchers. The data sets contain data from cancer patient surveillance linked with patient-reported outcome measures. These data provide researchers with the potential to investigate the health status and Health-Related Quality of Life (HRQOL) of older adults enrolled in MAOs with and without a cancer diagnosis. The SEER-MHOS data sets include SEER data linked with HOS data from baseline and follow up surveys collected during the same time period. Direct person identifiers (i.e., name, address, SSN, and the Medicare Health Insurance Claim number) and plan identifiers (i.e., contract number and plan name) are removed from the linked datasets. Researchers who are interested in using this linked data in their investigations may go to the following website for information:

<https://healthcaredelivery.cancer.gov/seer-mhos>.

HOS and the Star Ratings

Medicare Star Ratings

CMS developed the Medicare Star Ratings to help consumers compare health plans and providers based on quality and performance; to make accurate data more transparent and standardized among plans; and to reward top-performing health plans. Consumers can use the Medicare Plan Finder (MPF) tool (www.medicare.gov/find-a-plan) to search for health plans in their geographic area and compare cost estimates and coverage information. CMS rates the relative quality of service and care provided by MAOs based upon a five-star ratings scale that uses HOS measures combined with other measurement results. Up to 48 unique quality measures are included in the 2018 Medicare Part C and D Star Ratings. These measures include: providing preventive services, managing chronic illness, access to care, HEDIS measures, the Consumer Assessment of Healthcare Providers and Systems (CAHPS[®]) survey, and responsiveness.

The Medicare Part C Star Ratings include five contract level HOS measures: two measures of functional health and three HEDIS Effectiveness of Care measures.

The functional health measures are reported in each MAO's annual HOS Performance Measurement Report. The results are derived from the (VR-12) portion of the HOS, which serves as the core source for the PCS and MCS scores. The final measures are based on the case-mix adjusted PCS and MCS change scores between baseline and follow up surveys, as well as death status, in the Performance Measurement Results section.

- *Improving or Maintaining Physical Health* measure is the “Physical Health Percent Better or Same” result
- *Improving or Maintaining Mental Health* measure is the “Mental Health Percent Better or Same” result

The HEDIS Effectiveness of Care measures are reported in each MAO's annual HOS Baseline Report. These measures are calculated from questions about information and care beneficiaries receive from their healthcare providers, using data for the baseline and follow up cohorts from the same measurement year (i.e., a round of data). Beneficiary responses are used to derive the HEDIS measures: Management of Urinary Incontinence in Older Adults, Physical Activity in Older Adults, Fall Risk Management, and Osteoporosis Testing in Older Women. CMS uses three components of these four measures for the Medicare Star Ratings. Further information is available in the NCQA HEDIS Measures section.

- *Improving Bladder Control* measure is the Treatment of Urinary Incontinence rate
- *Monitoring Physical Activity* measure is the Advising Physical Activity rate
- *Reducing the Risk of Falling* measure is the Managing Fall Risk rate

2018 and 2019 Medicare Part C Star Ratings

The HOS cohorts related to data collection, report dissemination, and CMS Medicare Part C Star Ratings results are provided in the Medicare HOS Survey Administration Timeline Table below. This information will guide MAOs in understanding the sources of data used for specific Medicare Star Ratings Measures.

The 2018 Medicare Part C Star Ratings will be used by CMS as the basis for quality bonus payments to reward high-performing contracts in the MA program in the 2019 quality bonus payment year. The 2019 quality bonus payments are based on two HOS datasets (refer to the yellow highlighted section in the table below). For instance, the HOS *2014-2016 Cohort 17 Merged Baseline and Follow Up* dataset was used for the two PCS and MCS functional health measures, and the combined *2016 Cohort 19 Baseline and 2016 Cohort 17 Follow Up* dataset was used for the two HEDIS Effectiveness of Care measures.

The 2019 Medicare Part C Star Ratings will be used by CMS as the basis for quality bonus payments in the 2020 quality bonus payment year (refer to the green highlighted section in the Table below). For the 2020 quality bonus payments, the *2015-2017 Cohort 18 Merged Baseline and Follow Up* dataset will be used for the two PCS and MCS functional health measures, and the combined *2017 Cohort 20 Baseline and 2017 Cohort 18 Follow Up* dataset will be used for the three HEDIS Effectiveness of Care measures.

For more information about the Medicare Star Ratings, go to the CMS website at <http://go.cms.gov/partcanddstarratings>. For any questions related to Medicare Part C and D Star Ratings, you may send an email inquiry directly to PartCandDStarRatings@cms.hhs.gov. Please be sure to include your contract number in the email.

Medicare HOS Survey Administration and Star Ratings Timeline Table

Year	Baseline Data Collected	Follow Up Data Collected	Baseline Reports	Follow Up Reports	2-yr PCS/MCS Change for Star Ratings	HEDIS Measures for Star Ratings	Star Rating Year	Quality Bonus Payment Year
2020	Cohort 23	Cohort 21	Cohort 22	Cohort 20	2016-2018 Cohort 19	2018 Cohort 21 Baseline & 2018 Cohort 19 Follow-up	2020	2020
2019	Cohort 22	Cohort 20	Cohort 21	Cohort 19	2015-2017 Cohort 18	2017 Cohort 20 Baseline & 2017 Cohort 18 Follow-up	2019	2019
2018	Cohort 21	Cohort 19	Cohort 20	Cohort 18	2014-2016 Cohort 17	2016 Cohort 19 Baseline & 2016 Cohort 17 Follow-up	2018	2018
2017	Cohort 20	Cohort 18	Cohort 19	Cohort 17	2013-2015 Cohort 16	2015 Cohort 18 Baseline & 2015 Cohort 16 Follow-up	2017	2017
2016	Cohort 19	Cohort 17	Cohort 18	Cohort 16	2012-2014 Cohort 15	2014 Cohort 17 Baseline & 2014 Cohort 15 Follow Up	2016	2016

* Four HEDIS Effectiveness of Care Measures collected by the HOS are calculated from the combined round of baseline and follow up data by reporting year: *Management of Urinary Incontinence in Older Adults*; *Physical Activity in Older Adults*; *Fall Risk Management*; and *Osteoporosis Testing in Older Women*. Beginning with the 2012 Medicare Star Ratings, the Osteoporosis Testing in Older Women measure has moved to the display measures on the CMS website and is not part of the Star Ratings.

MAO Resources for Best Practices and the Star Ratings

A study titled “Analysis of Key Drivers of Improving or Maintaining Medicare Health Outcomes Survey (HOS) Scores” is available on the HOS website at http://www.hosonline.org/globalassets/hos-online/publications/key_drivers_medicare_hos_scores_2013.pdf.¹⁰ The study describes how two-year mortality and two-year changes in the VR-12 items relate to key HOS measures used in the Medicare Star Ratings. The HOS measures relate to maintaining and improving health and are derived from changes in the PCS and MCS scores. The results from this study clarify the properties of several CMS quality measures and identify which items most influence contract-level PCS and MCS scores.

A resource guide titled “Opportunities for Improving Medicare HOS Results through Practices in Quality Preventive Health Care for the Elderly” is available on the HOS website at http://hosonline.org/globalassets/hos-online/publications/opportunities_for_improving_medicare_hos_results_2012.pdf.¹¹ This guide helps MAOs develop and apply strategies that address the HOS items used in the CMS Medicare Part C Star Ratings. The guide includes an overview of the HOS, national performance results on HOS items included in the Medicare Part C Star Ratings, best practices in promoting quality preventive health care for the elderly, and HOS resources available to MAOs. Section 1 discusses the prevalence of conditions measured by the HOS items and summarizes national HOS results to highlight opportunities for improvement and intervention strategies. Section 2 provides examples of interventions that some MAOs have used to promote patient/physician communication, screening services, or maintenance of functional status among their beneficiaries.

A companion literature review titled “Functional Status in Older Adults: Intervention Strategies for Impacting Patient Outcomes” is available on the HOS website at http://www.hosonline.org/globalassets/hos-online/publications/functional_status_in_older_adults_2011.pdf.¹² This literature review synthesizes selected articles about functional status outcomes in older adults and supplements the resource guide. The included outcomes target assessments of health from well-established questionnaires that span the physical to psychological. In addition, outcome measures include ADLs that capture functional limitations in MA recipients. The articles were selected because they describe interventions that could impact functional status outcomes in elderly populations.

All three resources are available on the Resources page; the study results may be found in the Applications section and both the resource guide and literature review may be downloaded from the Trainings section at www.HOSonline.org.

2017 Cohort 20 Baseline Results

This report presents the Medicare HOS *2017 Cohort 20 Baseline* results for MAO HXXXXA and the national HOS Total. Additionally, the MAO level frequency distributions for the majority of the survey questions are available in Appendix 2 of this report. The aggregate data are provided to facilitate internal quality improvement activities. **Please be advised that the information in this report is not suitable for MAO level comparisons. Therefore, these data should not be used for public release or marketing purposes.**

Distribution of the Sample and Response Rates

The HOS *2017 Cohort 20 Baseline* included a random sample of 545,210 beneficiaries, both the aged and disabled, from 466 MAOs. The number of beneficiaries represents a 1.5% increase from the 537,259 beneficiaries from 459 MAOs in the HOS *2016 Cohort 19 Baseline*.

Of the 545,210 beneficiaries originally sampled for the *2017 Cohort 20 Baseline*, 12,086 were determined to be ineligible during the survey administration. Ineligible beneficiaries of the sample met one of the following criteria: deceased; not enrolled in the MAO; had an incorrect address and phone number; had a language barrier; or were removed from the sample due to age less than 18 years. Removing the ineligible beneficiaries from the total sample yielded the *Cohort 20 Baseline* eligible sample of 533,124.

Of the 533,124 beneficiaries in the eligible sample, 43.0% (229,330) completed the baseline survey. For the purposes of this report, a completed survey was defined as one that could be used to calculate a PCS or MCS score.¹

The 533,124 beneficiaries of the *Cohort 20 Baseline* eligible sample included 427,410 seniors (age 65 or older). Of the 427,410 eligible seniors sampled, 190,587 completed the baseline survey. This group of seniors comprised the *Cohort 20 Baseline* analytic sample. Please refer to Figure 2 on the following page for a graphical depiction of the response rates and distribution of the sample. MAOs with a small number of respondents should exercise **caution** when drawing conclusions from the results as the sample size may be insufficient to allow meaningful interpretation.

The average number of senior respondents per MAO was 408, with a minimum of 2 and a maximum of 661 respondents. The top 25% of MAOs had 500 or more senior respondents, while 25% had 326 or less. Ten percent of the MAOs had 540 or more respondents, and 10% had 203 or fewer respondents. Based on the analytic criteria, the mean MAO level response rate at baseline for seniors was 44.3%, with a minimum response rate of 5.9% and a maximum of 62.8%. The top 25% of MAOs had a response rate of 49.4% or greater, while 25% had a response rate of 40.8% or less. Ten percent of the MAOs had a response rate of 52.9% or higher and 10% had a response rate of 33.6% or lower.

¹ The overall response rates in the report are calculated after data processing and score calculation. An initial overall survey completion rate was calculated by NCQA following the data collection and used the criteria of at least 80% completion of survey items and all 6 Activity of Daily Living (ADL) questions answered. This initial rate may be reported elsewhere and will differ from the overall response rate in this report.

Figure 2 illustrates the calculation of the response rates, the distribution of the eligible sample, and the process for determining the number of beneficiaries in the analytic sample for MAO HXXXXA and the HOS Total. All analyses in this report use the *Cohort 20 Baseline* analytic sample, except for the NCQA HEDIS Measures section.

Figure 2: 2017 Cohort 20 Baseline Distribution of the Sample and Response Rates for MAO HXXXXA and HOS Total

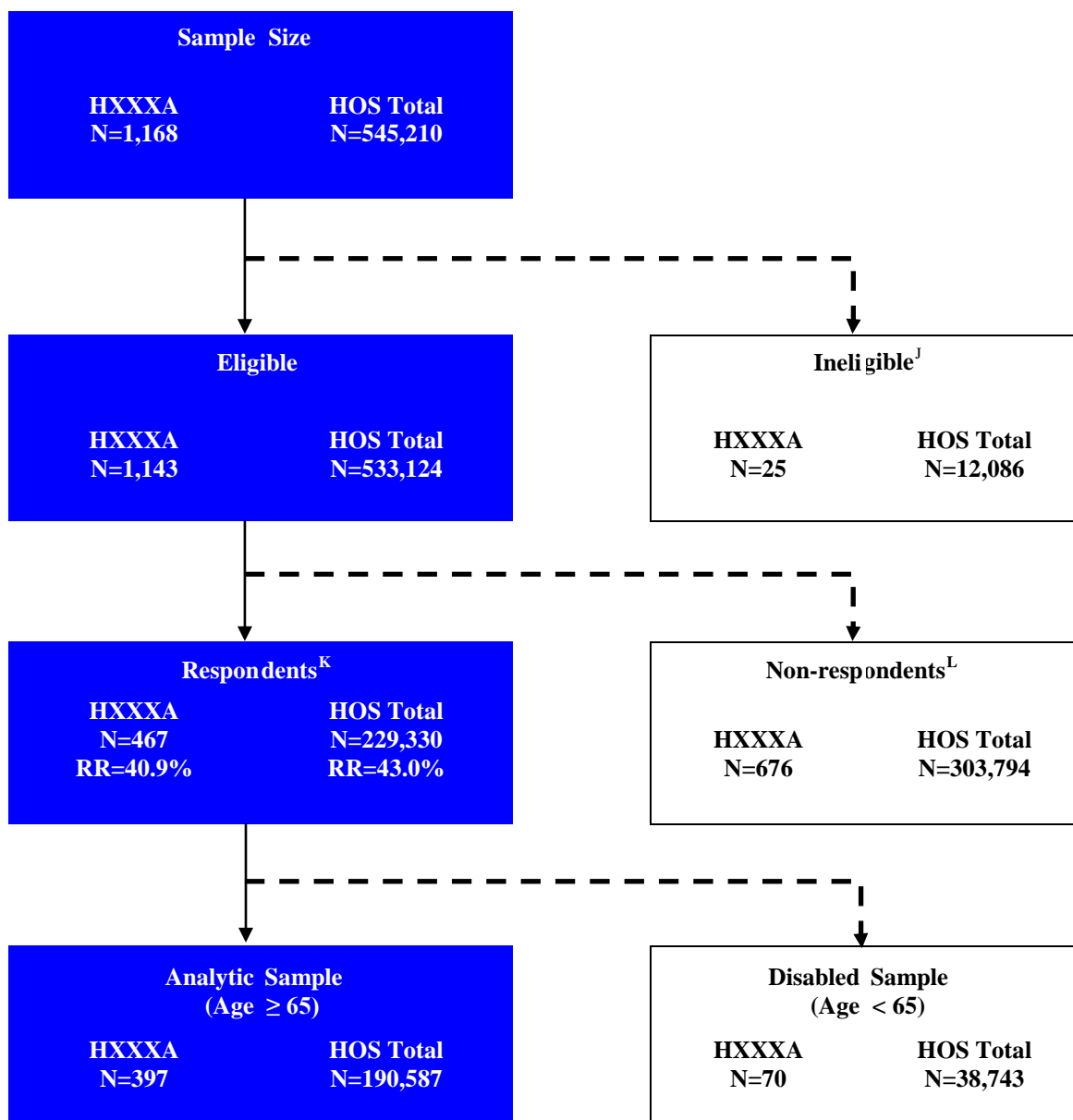

^J Deceased, not enrolled in MAO, incorrect address and phone, language barrier, or removed from sample due to age less than 18 years.

^K Response Rate = [(Respondents/Eligible Sample) x 100%].

^L Surveys for which PCS and MCS scores cannot be calculated.

Demographics

Table 11 presents demographics for MAO HXXXXA and the HOS Total. The mean age for the HOS Total sample was 74.6 years (not shown in the table). HOS demographics in the table are detailed by sub-categories within the age, gender, race, marital status, education, annual household income, and Medicaid status groups.

Table 11: 2017 Cohort 20 Baseline Demographics for MAO HXXXXA and HOS Total

HOS Demographic	MAO HXXXXA N (%)	HOS Total N (%)
Age	(N=397)	(N=190,587)
65-69	127 (32.0%)	56,609 (29.7%)
70-74	109 (27.5%)	51,887 (27.2%)
75-79	72 (18.1%)	36,882 (19.4%)
80-84	45 (11.3%)	24,098 (12.6%)
85+	44 (11.1%)	21,111 (11.1%)
Gender	(N=397)	(N=190,587)
Male	168 (42.3%)	79,113 (41.5%)
Female	229 (57.7%)	111,474 (58.5%)
Race	(N=397)	(N=190,587)
White	299 (75.3%)	147,705 (77.5%)
Black	60 (15.1%)	23,045 (12.1%)
Other/Unknown	38 (9.6%)	19,837 (10.4%)
Marital Status	(N=369)	(N=179,619)
Married	192 (52.0%)	91,321 (50.8%)
Widowed	77 (20.9%)	43,749 (24.4%)
Divorced or Separated	75 (20.3%)	34,233 (19.1%)
Never Married	25 (6.8%)	10,316 (5.7%)
Education	(N=363)	(N=177,721)
Did Not Graduate HS	76 (20.9%)	36,460 (20.5%)
High School Graduate	105 (28.9%)	55,375 (31.2%)
Some College	92 (25.3%)	45,083 (25.4%)
4 Year Degree or Beyond	90 (24.8%)	40,803 (23.0%)
Annual Household Income	(N=344)	(N=166,609)
Less than \$10,000	53 (15.4%)	23,792 (14.3%)
\$10,000-\$19,999	59 (17.2%)	29,031 (17.4%)
\$20,000-\$29,999	45 (13.1%)	23,568 (14.1%)
\$30,000-\$49,999	57 (16.6%)	31,315 (18.8%)
\$50,000 or More	82 (23.8%)	37,534 (22.5%)
Don't Know	48 (14.0%)	21,369 (12.8%)
Medicaid Status	(N=397)	(N=190,551)
Medicaid	96 (24.2%)	47,482 (24.9%)
Non-Medicaid	301 (75.8%)	143,069 (75.1%)

Physical and Mental Component Summary Scores

Definition of Measures

- The HOS health status measures are the PCS score and the MCS score. These scores are calculated from the VR-12 (Questions 1-7 in the 2017 HOS 3.0) which asks respondents about their usual activities and how they would rate their health.
- The VR-12 is a barometer of physical and mental health status. Concepts included in the measures are: physical functioning, role limitations due to physical problems (role-physical), bodily pain, general health, vitality, role limitations due to emotional problems (role-emotional), social functioning, and mental health.
- A higher PCS or MCS score reflects better health status. The PCS and MCS scores are case-mix adjusted^M to allow for equitable comparisons across all MAOs.

How Is Your MAO Doing?

Figure 3 depicts the mean adjusted PCS and MCS scores for MAO HXXXXA and the HOS Total. For the HOS Total, the mean PCS of 39.1 indicates that the physical health status of seniors is substantially lower, on average, than the mean PCS of 50 (SD=10) for the general U.S. population. The mean MCS of 52.8 indicates that the mental health status of seniors is slightly higher, on average, than the mean MCS of 50 (SD=10) for the general U.S. population.

For additional mean unadjusted and adjusted PCS and MCS scores, refer to the Executive Summary section. **Please note that only adjusted scores are displayed in the tables and graphs in the remainder of the report.**

Figure 3: 2017 Cohort 20 Baseline Mean Adjusted PCS and MCS Scores for MAO HXXXXA and HOS Total

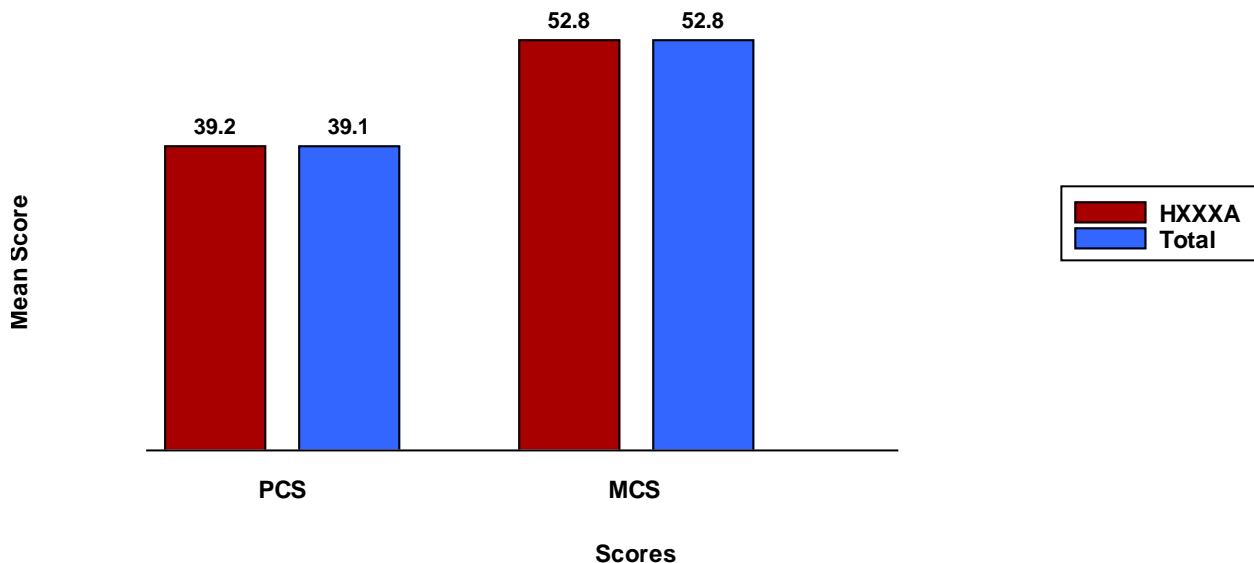

^M Case-mix adjustment is a statistical technique that controls for differences in demographics, socioeconomic characteristics, chronic medical conditions, and HOS study design variables. For additional information about case-mix adjustment and scoring for the VR-12, please refer to Appendix 1.

General Health and Comparative Health

Definition of Measures

- General health status is a self-reported measure of health perception using ratings of “Excellent,” “Very good,” “Good,” “Fair,” or “Poor.”¹³ This measure is found in Question 1.
- Two measures of physical and mental health compared to one year ago use ratings of “Much better,” “Slightly better,” “About the same,” “Slightly worse,” or “Much worse.” These measures are found in Questions 8 and 9.

General self-rated health status is a valid and reliable method for assessing health across different populations.² Individuals who indicate that their general health was “Fair” or “Poor,” or that their physical or mental health compared to one year ago was “Slightly worse” or “Much worse,” are known to be at increased risk for near future hospitalization, use of mental health services, and mortality.^{14,15}

How Is Your MAO Doing?

Figure 4 displays the respondents’ self-reported general health status for your MAO and the HOS Total.

Figure 4: 2017 Cohort 20 Baseline Self-Rated General Health Status for MAO HXXXXA and HOS Total

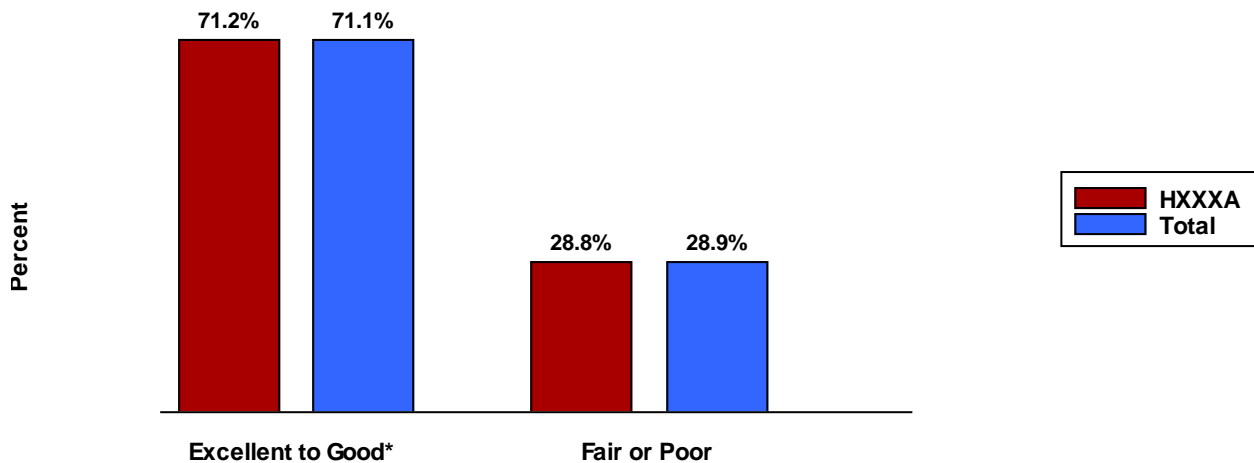

* Categories for general health included “Excellent,” “Very good,” or “Good.”

Figure 5 displays the respondents' self-reported physical health status as compared to one year ago for your MAO and the HOS Total.

Figure 5: 2017 Cohort 20 Baseline Self-Rated Physical Health Compared to One Year Ago for MAO HXXXXA and HOS Total

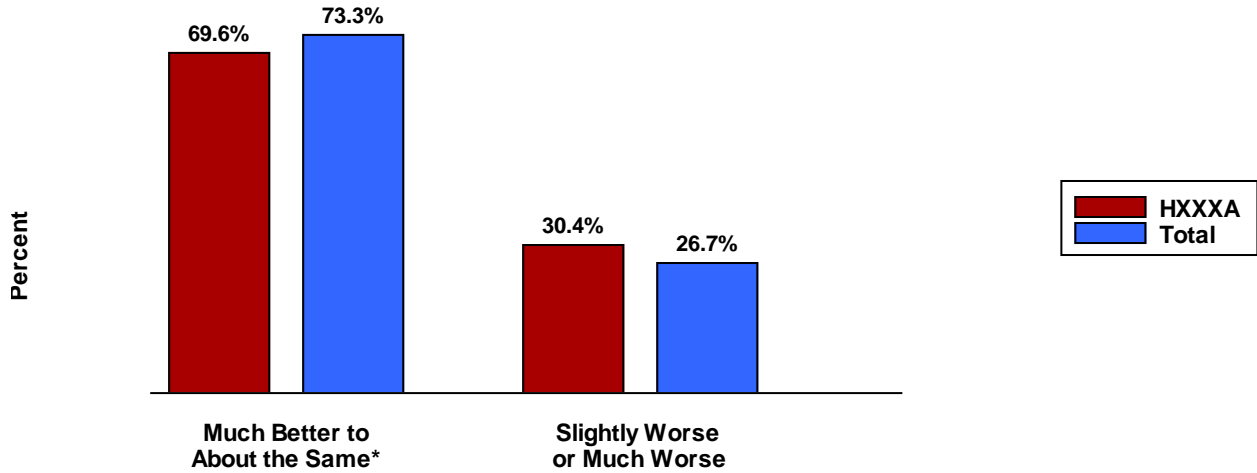

* Categories for comparative health included "Much better," "Slightly better," or "About the same."

Figure 6 displays the respondents' self-reported mental health status as compared to one year ago for your MAO and the HOS Total.

Figure 6: 2017 Cohort 20 Baseline Self-Rated Mental Health Compared to One Year Ago for MAO HXXXXA and HOS Total

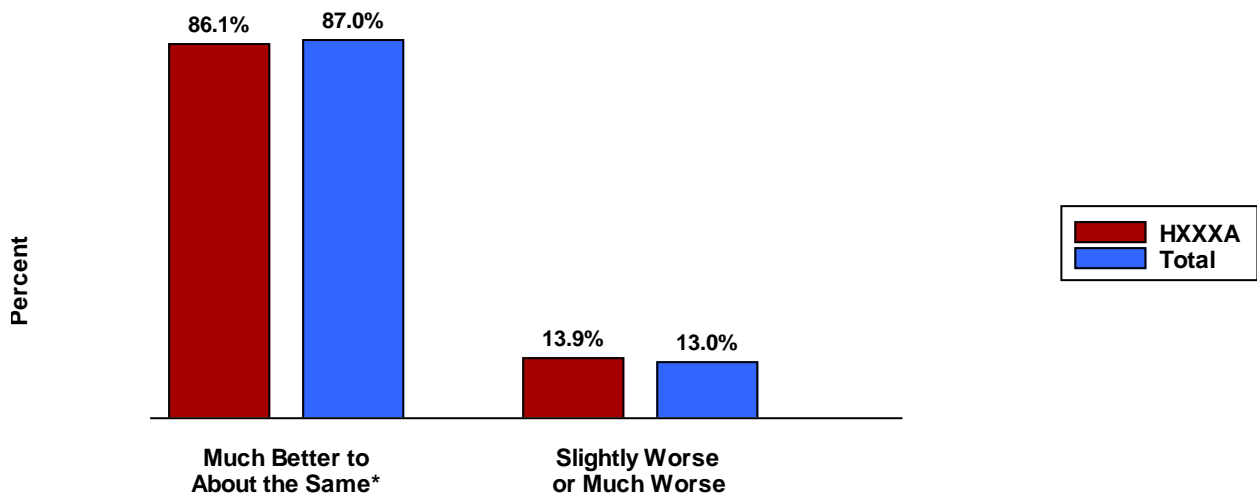

* Categories for comparative health included "Much better," "Slightly better," or "About the same."

Table 12 compares the self-reported general and comparative health status measures by adjusted PCS and MCS scores for MAO HXXXXA and the HOS Total.

Table 12: 2017 Cohort 20 Baseline Mean Adjusted Scores by Self-Rated General and Comparative Health Status for MAO HXXXXA and HOS Total

Self-Rated Health Status	MAO HXXXXA		HOS Total	
	PCS Mean (SD)	MCS Mean (SD)	PCS Mean (SD)	MCS Mean (SD)
General Health				
Excellent to Good*	41.0 (6.5)	54.1 (5.1)	41.1 (6.4)	54.3 (5.0)
Fair or Poor	34.6 (5.8)	49.5 (5.3)	34.2 (6.5)	49.3 (6.0)
Comparative Health-Physical				
Much Better to About the Same*	40.7 (6.9)	53.6 (5.4)	40.5 (6.8)	53.7 (5.3)
Slightly Worse or Much Worse	36.3 (6.2)	51.0 (5.8)	35.5 (7.1)	50.5 (6.3)
Comparative Health-Mental				
Much Better to About the Same*	39.8 (7.0)	53.7 (5.1)	39.8 (6.9)	53.5 (5.4)
Slightly Worse or Much Worse	35.9 (6.5)	47.6 (6.0)	34.9 (7.5)	48.4 (6.6)

* Categories for general health included "Excellent," "Very good," or "Good."

Categories for comparative health included "Much better," "Slightly better," or "About the same."

Depression

Definition of Measure

- The HOS includes two questions (Questions 39a and 39b) that serve as a screening measure for depression.^N Each question is assigned points depending on the response given, from 0 (“not at all”) to 3 (“nearly every day”). For this report, a Medicare beneficiary is considered to have a positive depression screen when he or she scores three points or greater on the combined total points of the two depression questions, when both questions are answered.

Individuals with a positive depression screen may be at risk for depressive disorders. Depression is underdiagnosed in the elderly Medicare population, and is a significant health problem that has been linked to poor health outcomes.^{16, 17} Older adults may suffer mental distress associated with limitations in daily activities, physical impairments, grief from loss of loved ones, changes in living situations, or untreated mental illness.¹⁸ Additionally, depression is significantly associated with other psychological dysfunction, as well as the presence of common chronic medical conditions, such as diabetes.^{19, 20} Depression screening tools have been developed for use in clinical settings to rapidly identify individuals at risk for major depression. Those with positive depression screens should be followed-up by more comprehensive diagnostic evaluations to identify whether or not they have major depression.^{21, 22} Evidence-based programs have been developed to improve mental health among older adults. Social supports through local area agencies may also be effective.¹⁸

How Is Your MAO Doing?

Table 13 depicts beneficiaries with a positive depression screen, and the distribution of responses to the two individual depression questions for MAO HXXXXA and the HOS Total.

Table 13: 2017 Cohort 20 Baseline Frequency of Positive Depression Screen for MAO HXXXXA and HOS Total

Depression Screening Questions	MAO HXXXXA N (%)	HOS Total N (%)
Little interest or pleasure in doing things in past two weeks		
Not at all (0 pt)	250 (67.4%)	119,441 (67.1%)
Several days (1 pt)	69 (18.6%)	33,862 (19.0%)
More than half the days (2 pt)	22 (5.9%)	12,729 (7.1%)
Nearly every day (3 pt)	30 (8.1%)	12,100 (6.8%)
Feeling down, depressed, or hopeless in past two weeks		
Not at all (0 pt)	278 (74.3%)	131,925 (74.0%)
Several days (1 pt)	65 (17.4%)	31,335 (17.6%)
More than half the days (2 pt)	15 (4.0%)	8,506 (4.8%)
Nearly every day (3 pt)	16 (4.3%)	6,624 (3.7%)
Positive Depression Screen*	49 (13.4%)	23,707 (13.5%)

* A positive depression screen is defined as scoring 3 points or greater on the sum total of the two depression questions, when both questions are answered.

^N Beginning with the 2013 HOS 2.5, two depression screening questions from the Patient Health Questionnaire-2 (PHQ-2) replaced the questions that served as the depression screening measure in previous versions of the HOS. Due to the new depression screening methodology, estimates of the proportion with positive depression screens in this report are not comparable to estimates produced using the HOS versions 1.0 or 2.0.

Pain

Definition of Measure

- The HOS includes three questions to measure self-reported pain over the previous seven days. Question 36 asks how much pain interfered with day-to-day activities and question 37 asks how often pain kept the beneficiary from socializing. Both questions 36 and 37 have five possible categorical responses. Question 38 asks the beneficiary to rate his/her average pain, ranging from 1 (“no pain”) to 10 (“worst imaginable pain”).

Self-reported pain is common among seniors. Without proper pain management, opioid abuse^{23, 24} and alcohol abuse²⁵ are increasing among seniors as they attempt to control their pain. Several organizations have published recommendations on what should be done to improve the safety of opioid prescribing, including decreasing the risk of addiction and abuse.²⁶

Pain screening is the initial step in establishing an appropriate pain management program for elderly beneficiaries. In fact, The Joint Commission requires assessment and management of pain when clinically indicated for patients in accredited hospitals, clinics, and long-term care facilities, while minimizing the risks associated with treatment.²⁶ Physical activity and complementary medicine techniques may be helpful alternatives in relieving certain types of pain.²⁷

How Is Your MAO Doing?

Figure 7 shows the distribution of self-reported pain scores, grouped into categories, for MAO HXXXA and the HOS Total.

Figure 7: 2017 Cohort 20 Baseline Frequency of Self-Rated Pain Score for MAO HXXXA and HOS Total

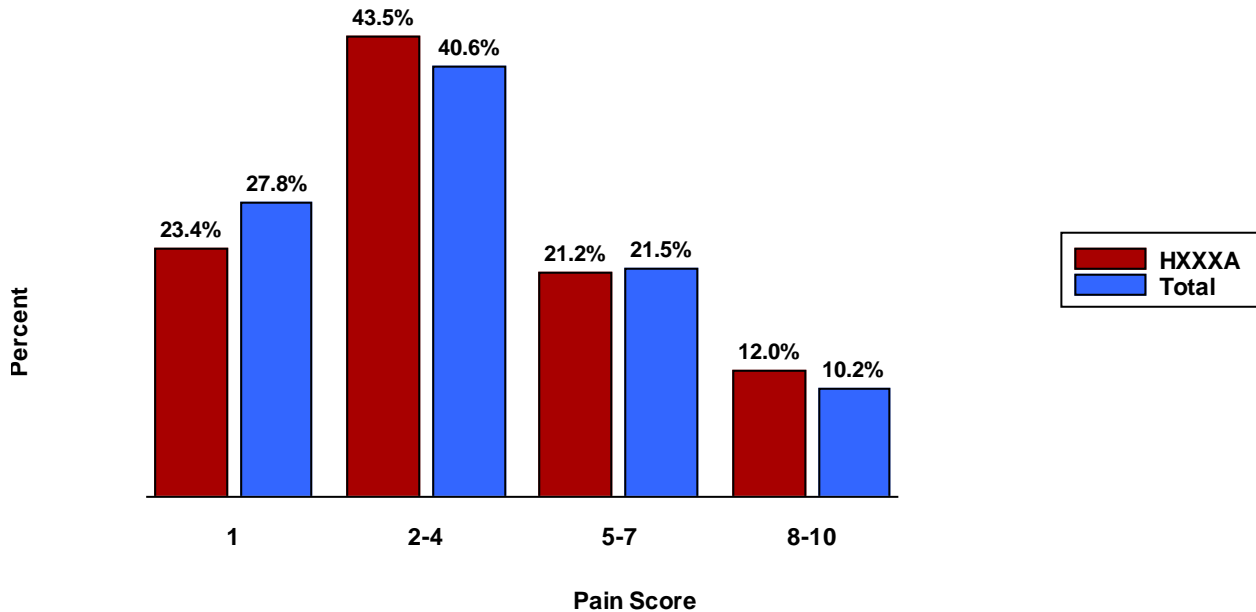

Figure 8 illustrates the relationship between the reported extent that pain interfered with day-to-day activities and mean adjusted PCS score for MAO HXXXA and the HOS Total.

Figure 8: 2017 Cohort 20 Baseline Mean Adjusted PCS Score by Extent Pain Interfered with Day-to-Day Activities for MAO HXXXA and HOS Total

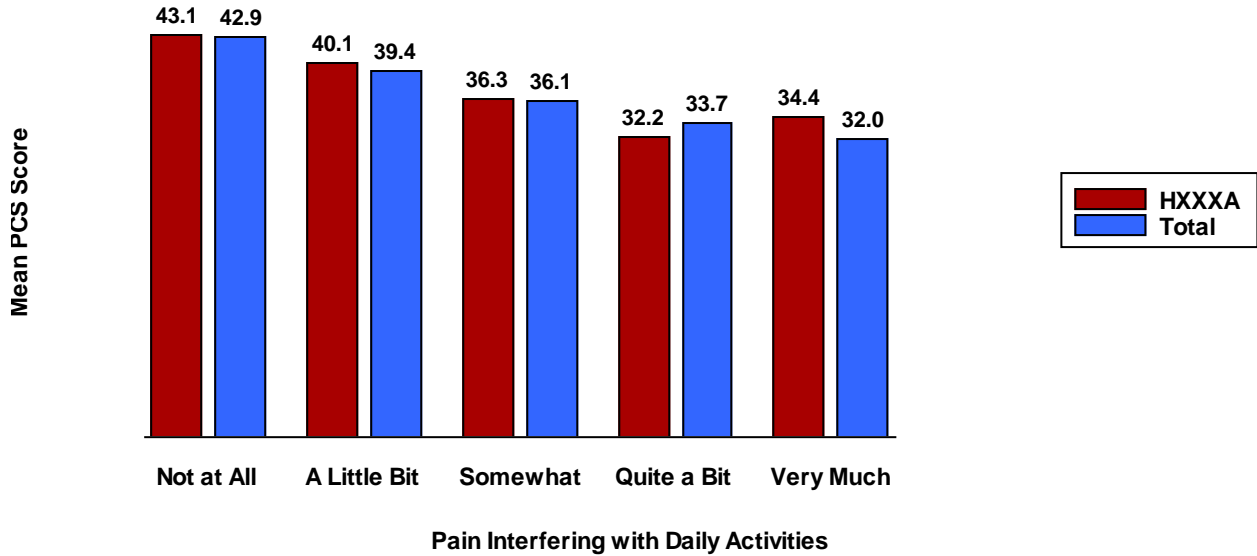
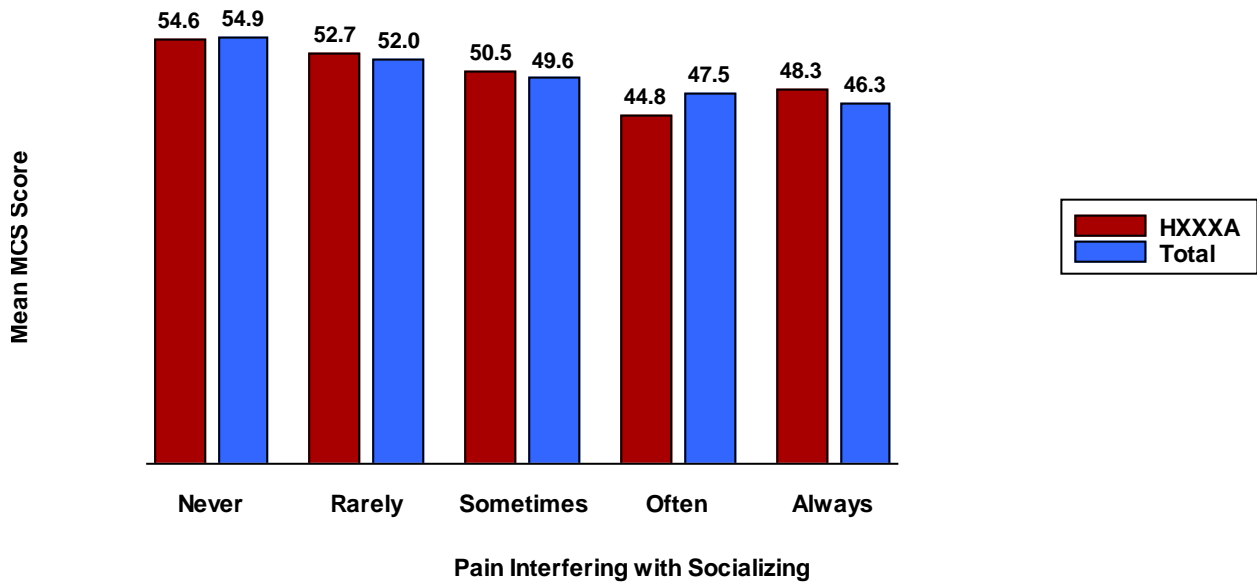

Figure 9 shows the relationship between the reported extent that pain interfered with socialization with others and mean adjusted MCS score for MAO HXXXA and the HOS Total.

Figure 9: 2017 Cohort 20 Baseline Mean Adjusted MCS Score by Extent Pain Interfered with Socializing with Others for MAO HXXXA and HOS Total



Chronic Medical Conditions

Definition of Measures

- Chronic medical conditions are multiple measures of the prevalence of chronic disease across the beneficiary lifespan. Chronic conditions are those that last a year or more, and require ongoing medical attention and/or limit activities of daily living. Fifteen measures are found in Questions 20-34.

For older adults, the presence of chronic medical conditions can reduce the quality of life, accelerate a decline in functioning, and lead to conflicting medical advice when care is not coordinated.²⁸ The increased cost associated with chronic disease is an important factor driving overall Medicare spending.²⁹ According to the U.S. Department of Health and Human Services, two of three adults over the age of 65 have two or more chronic conditions and the need for coordinated care.³⁰ An important feature of the Medicare HOS is the ability to report and quantify self-reported chronic conditions in the Medicare Advantage (MA) population. A longitudinal study using HOS data concluded that multiple conditions at baseline and the 2-year follow up were associated with worse health in terms of ADLs and HRQOL, and are important outcomes for intervention to improve long-term health.³¹

How Is Your MAO Doing?

Table 14 shows the prevalence of 15 chronic medical conditions in your MAO and the HOS Total. Depression was added to the list of chronic medical conditions in the 2013 HOS 2.5. The chronic medical conditions are quantified in the HOS when beneficiaries positively respond to the question, “Has a doctor ever told you that you had (the specified condition)?”

Table 14: 2017 Cohort 20 Baseline Prevalence of Chronic Medical Conditions for MAO HXXXXA and HOS Total

Medical Condition	MAO HXXXXA N (%)	HOS Total N (%)
Hypertension	254 (68.1%)	121,192 (66.7%)
Arthritis - Hip or Knee	162 (43.8%)	80,854 (44.7%)
Arthritis - Hand or Wrist	130 (35.3%)	66,753 (37.0%)
Diabetes	118 (31.6%)	51,342 (28.3%)
Sciatica	105 (28.3%)	46,984 (26.1%)
Other Heart Conditions	74 (19.8%)	38,083 (21.1%)
Osteoporosis	74 (20.1%)	37,129 (20.6%)
Depression	76 (20.4%)	36,369 (20.1%)
Pulmonary Disease	65 (17.3%)	33,561 (18.5%)
Any Cancer (except skin cancer)	46 (12.7%)	25,796 (14.7%)
Coronary Artery Disease	41 (11.2%)	23,268 (13.0%)
Congestive Heart Failure	32 (8.6%)	16,043 (8.9%)
Myocardial Infarction	25 (6.7%)	15,932 (8.8%)
Stroke	23 (6.1%)	14,720 (8.1%)
Gastrointestinal Disease	19 (5.1%)	9,598 (5.3%)

An earlier study of HOS beneficiaries found that beneficiaries with multiple chronic conditions and risk for depression had the largest mental health decline over the two-year follow up period. In this study, people with multiple chronic conditions had greater risks for mortality, poor functional status, unnecessary hospitalizations, adverse drug events, duplicative tests, and conflicting medical advice.³²

Figure 10 illustrates the distribution of beneficiaries by number of chronic medical conditions, including categories of none, one, two or three, and four or more chronic conditions for MAO HXXXXA. Compare the percentage of beneficiaries in your MAO who have multiple chronic conditions with the HOS Total.

Figure 10: 2017 Cohort 20 Baseline Distribution of Chronic Medical Conditions for MAO HXXXXA and HOS Total

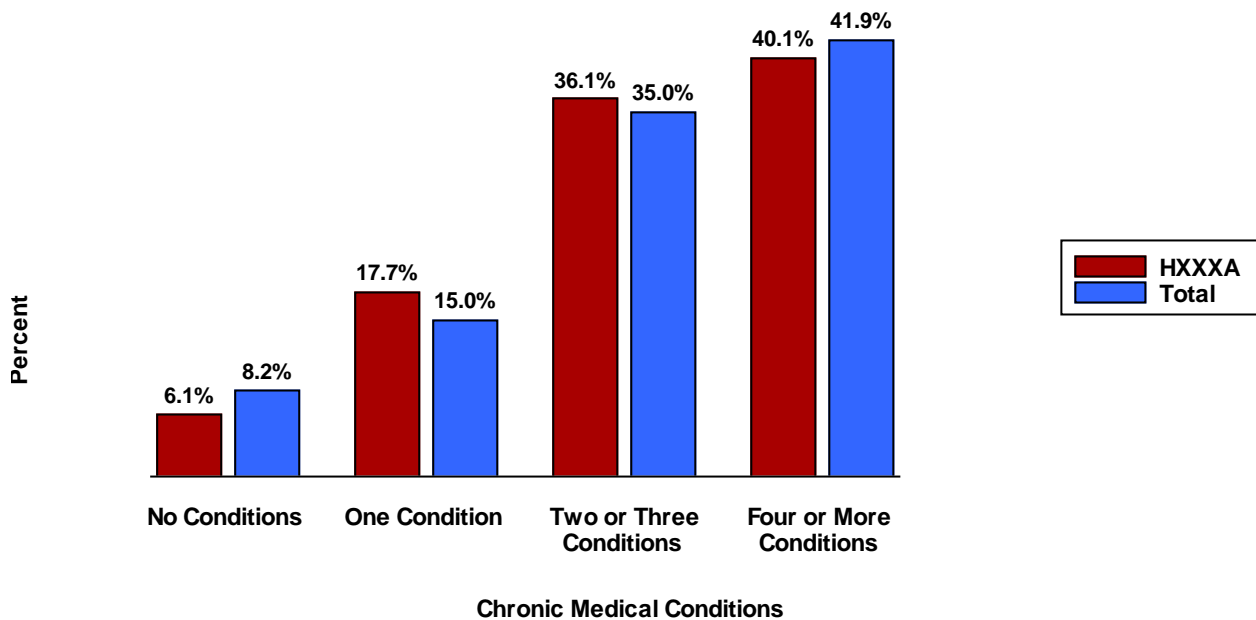

Activities of Daily Living

Definition of Measures

- ADLs refer to a set of common daily tasks that are necessary for personal self-care and independent living.³³ ADLs include bathing, dressing, eating, getting in or out of chairs, walking, and using the toilet. These measures are found in Question 10. Impairment with ADLs is defined as beneficiaries who reported either difficulty or inability to perform the specific ADL (“Yes, I have difficulty” or “I am unable to do this activity”).
- Instrumental activities of daily living (IADLs) assess independent living skills that are more complex than ADLs.^{34, 35} IADLs include preparing meals, managing money, and taking medications. These measures are found in Question 11. For IADLs, impairment is defined as beneficiaries who reported difficulty performing the specific IADL (“Yes, I have difficulty”).

Six ADLs are included in the HOS to examine reported difficulty with the performance of daily tasks. The ability to perform these tasks is predictive of current disease status and mortality risk.^{36, 37} Regular assessment of functional status is recommended for improving the effectiveness of care, especially for older adults prior to hospital discharge and those living with dementia.³⁷ Like the Healthy Days Measures, ADLs are considered foundational health indicators; therefore, they are tracked by the federal Healthy People 2020 program.¹³

There are three IADLs in the HOS that examine reported difficulty with the performance of tasks of independence. In comparison to the ADLs, IADLs are considered to recognize earlier changes in functioning, and can be used as an indication of the need for intervention or further medical work-up.³⁵

How Is Your MAO Doing?

Table 15 highlights the prevalence of impairments in performing ADLs and IADLs for beneficiaries in MAO HXXXXA and the HOS Total.

Table 15: 2017 Cohort 20 Baseline Prevalence of Impairments in ADLs and IADLs for MAO HXXXXA and HOS Total

Impairment Type	MAO HXXXXA Impairments N (%)	HOS Total Impairments N (%)
Activities of Daily Living		
Walking	132 (34.6%)	60,039 (33.0%)
Getting in or out of chairs	89 (23.4%)	39,599 (21.7%)
Bathing	61 (16.0%)	29,282 (16.0%)
Dressing	47 (12.3%)	22,852 (12.5%)
Using the Toilet	40 (10.5%)	16,305 (8.9%)
Eating	20 (5.2%)	9,437 (5.1%)
Instrumental Activities of Daily Living*		
Preparing meals	41 (11.7%)	18,815 (11.4%)
Managing money	21 (5.8%)	9,802 (5.7%)
Taking medication as prescribed	16 (4.4%)	9,335 (5.4%)

*Respondents that indicated “I don’t do this activity” to IADL questions were removed from the denominator.

Table 16 presents the mean adjusted PCS scores for MAO HXXXXA and the HOS Total by level of impairment across ADLs and IADLs. You may compare those beneficiaries with and without impairments in your MAO to the HOS Total.

Table 16: 2017 Cohort 20 Baseline Mean Adjusted PCS Score by ADL and IADL Impairment Status for MAO HXXXXA and HOS Total

Impairment Type	MAO HXXXXA		HOS Total	
	Impairment PCS Mean (SD)	No Impairment PCS Mean (SD)	Impairment PCS Mean (SD)	No Impairment PCS Mean (SD)
Activities of Daily Living				
Walking	35.6 (6.2)	41.3 (6.6)	34.4 (6.6)	41.5 (6.3)
Getting in or out of chairs	35.0 (6.1)	40.6 (6.7)	33.6 (6.7)	40.7 (6.5)
Bathing	33.9 (6.2)	40.4 (6.6)	32.9 (6.7)	40.4 (6.6)
Dressing	33.3 (6.6)	40.2 (6.6)	32.6 (7.0)	40.1 (6.7)
Using the Toilet	34.1 (6.6)	39.9 (6.8)	32.3 (7.1)	39.8 (6.8)
Eating	33.5 (4.3)	39.6 (7.0)	32.4 (7.4)	39.5 (7.0)
Instrumental Activities of Daily Living*				
Preparing meals	32.9 (6.0)	40.5 (6.6)	33.3 (6.6)	40.5 (6.5)
Managing money	36.9 (7.8)	39.8 (6.9)	33.4 (7.0)	39.9 (6.8)
Taking medication as prescribed	31.4 (5.7)	39.6 (6.8)	32.1 (7.1)	39.6 (6.8)

*Respondents that indicated “I don’t do this activity” to IADL questions were removed from the denominator.

Table 17 presents the mean adjusted MCS scores for MAO HXXXXA and the HOS Total by level of impairment across ADLs and IADLs. You may compare those beneficiaries with and without impairments to the HOS Total.

Table 17: 2017 Cohort 20 Baseline Mean Adjusted MCS Score by ADL and IADL Impairment Status for MAO HXXXXA and HOS Total

Impairment Type	MAO HXXXXA		HOS Total	
	Impairment MCS Mean (SD)	No Impairment MCS Mean (SD)	Impairment MCS Mean (SD)	No Impairment MCS Mean (SD)
Activities of Daily Living				
Walking	50.8 (5.6)	53.9 (5.4)	50.1 (6.2)	54.2 (5.0)
Getting in or out of chairs	50.5 (5.6)	53.5 (5.4)	49.4 (6.4)	53.9 (5.2)
Bathing	48.6 (5.7)	53.7 (5.2)	48.4 (6.3)	53.7 (5.3)
Dressing	49.0 (5.2)	53.4 (5.4)	48.1 (6.4)	53.6 (5.3)
Using the Toilet	48.8 (5.4)	53.3 (5.5)	47.8 (6.5)	53.4 (5.5)
Eating	49.7 (5.2)	53.0 (5.6)	47.3 (6.5)	53.2 (5.6)
Instrumental Activities of Daily Living*				
Preparing meals	49.1 (4.8)	53.7 (5.2)	48.7 (6.2)	53.8 (5.2)
Managing money	49.5 (5.8)	53.3 (5.3)	47.6 (6.3)	53.5 (5.4)
Taking medication as prescribed	45.3 (6.2)	53.2 (5.4)	46.8 (6.4)	53.3 (5.4)

*Respondents that indicated “I don’t do this activity” to IADL questions were removed from the denominator.

Table 18 shows the survey respondents by the number of ADL impairments including categories of none, one, two, and three or more ADL impairments for beneficiaries in MAO HXXXXA and the HOS Total.

Table 18: 2017 Cohort 20 Baseline Number of ADL Impairments for MAO HXXXXA and HOS Total

Number of ADL Impairments	MAO HXXXXA N (%)	HOS Total N (%)
None	232 (60.3%)	114,376 (62.1%)
1 ADL Impairment	56 (14.5%)	25,488 (13.8%)
2 ADL Impairments	38 (9.9%)	16,781 (9.1%)
3 or More ADL Impairments	59 (15.3%)	27,483 (14.9%)

Figure 11 shows the relationship between increasing numbers of ADL impairments and mean adjusted PCS scores for MAO HXXXXA and the HOS Total.

Figure 11: 2017 Cohort 20 Baseline Mean Adjusted PCS Scores by Number of ADL Impairments for MAO HXXXXA and HOS Total

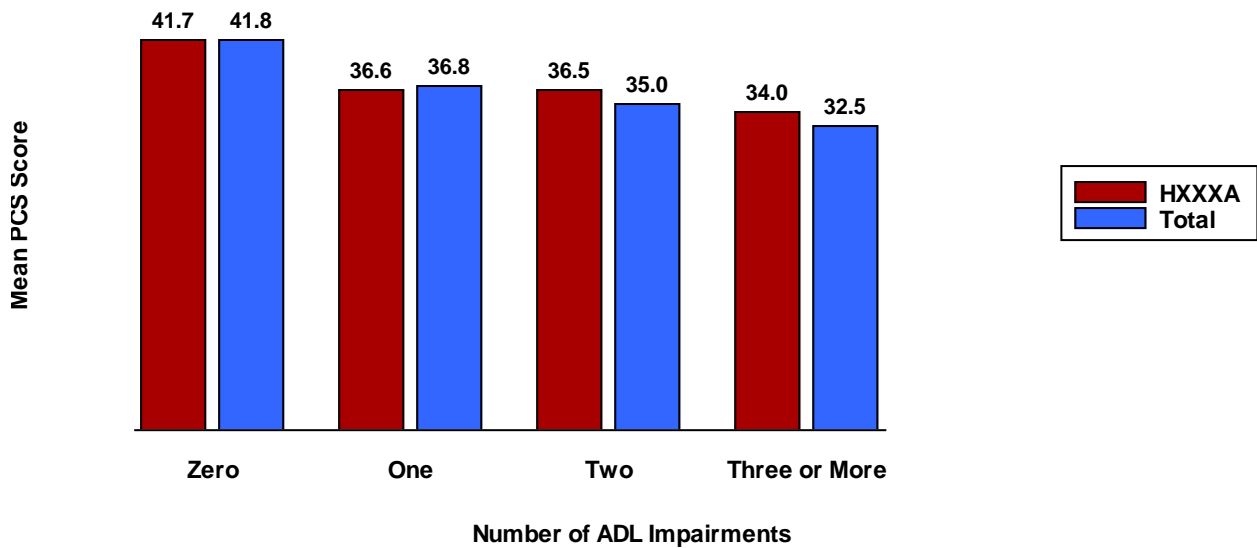
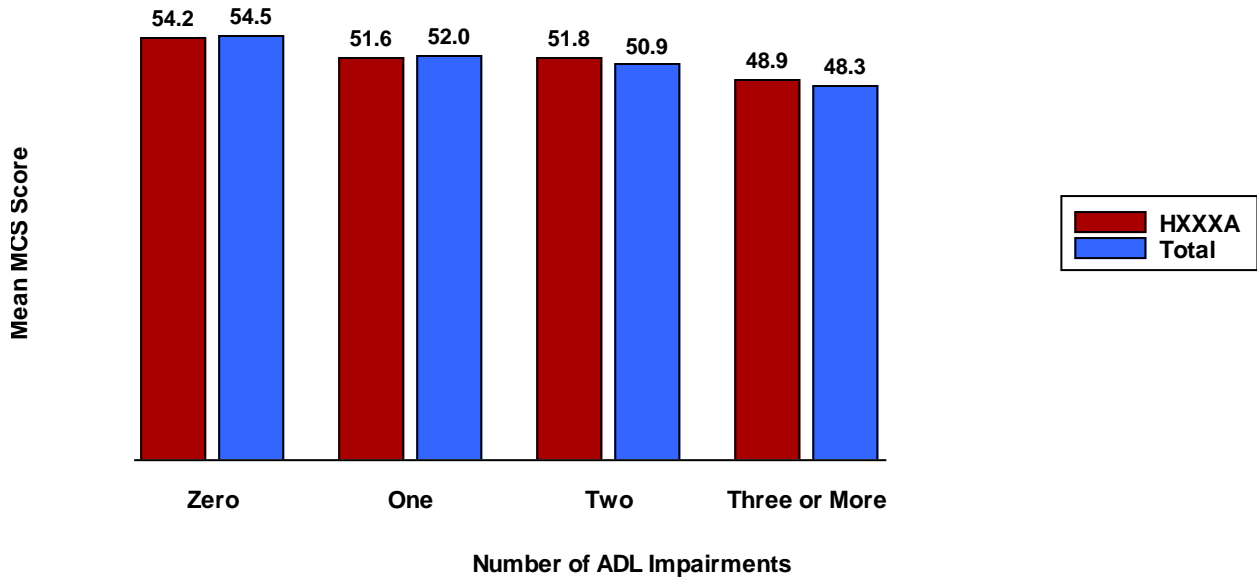

Figure 12 illustrates the relationship between increasing numbers of ADL impairments and mean adjusted MCS scores for MAO HXXXXA and the HOS Total.

Figure 12: 2017 Cohort 20 Baseline Mean Adjusted MCS Scores by Number of ADL Impairments for MAO HXXXXA and HOS Total



Healthy Days Measures

Definition of Measures

- Physically unhealthy days is a self-reported measure of the number of days during the past 30 days when physical health was not good. The measure is found in Question 12.
- Mentally unhealthy days is a self-reported measure of the number of days during the past 30 days when mental health was not good. The measure is found in Question 13.
- Days with activity limitations is a self-reported measure of the number of days during the past 30 days when poor physical or mental health kept the beneficiary from usual activities. The measure is found in Question 14.

Healthy Days Measures provide key information on the functional status of vulnerable sub-populations, and are used to assess the HRQOL³⁸ across the U.S. As sentinel indicators of present and future disease and injury risk, MAOs may use Healthy Days Measures to identify vulnerable sub-populations for effective preventative care and disease management. According to the CDC, “In recent years, several organizations have found these Healthy Days Measures useful at the national, state, and community levels for (1) identifying health disparities, (2) tracking population trends, and (3) building broad coalitions around a measure of population health compatible with the World Health Organization’s definition of health.”³⁹ The CDC HRQOL program considers 14 or more unhealthy days in the past 30 days as an indicator of poor well-being.⁴

How Is Your MAO Doing?

Table 19 provides the frequency distributions of Healthy Days Measures for the MAO and HOS Total.

Table 19: 2017 Cohort 20 Baseline Distribution of Healthy Days Measures for MAO HXXXXA and HOS Total

Healthy Days Measures	MAO HXXXXA N (%)	HOS Total N (%)
Physically Unhealthy Days		
None	193 (53.5%)	92,186 (52.6%)
1-13	89 (24.7%)	45,585 (26.0%)
14-30*	79 (21.9%)	37,555 (21.4%)
Mentally Unhealthy Days		
None	247 (68.4%)	116,881 (66.4%)
1-13	70 (19.4%)	37,277 (21.2%)
14-30*	44 (12.2%)	21,772 (12.4%)
Days with Activity Limitations		
None	238 (65.2%)	121,224 (68.4%)
1-13	64 (17.5%)	29,170 (16.5%)
14-30*	63 (17.3%)	26,873 (15.2%)

*Fourteen or more unhealthy days in the previous 30 days indicates poor well-being.

Figure 13 depicts the relationship between the reported number of days with activity limitations during the previous 30 days and mean adjusted PCS scores.

Figure 13: 2017 Cohort 20 Baseline Mean Adjusted PCS Scores by Number of Days with Activity Limitations for MAO HXXXA and HOS Total

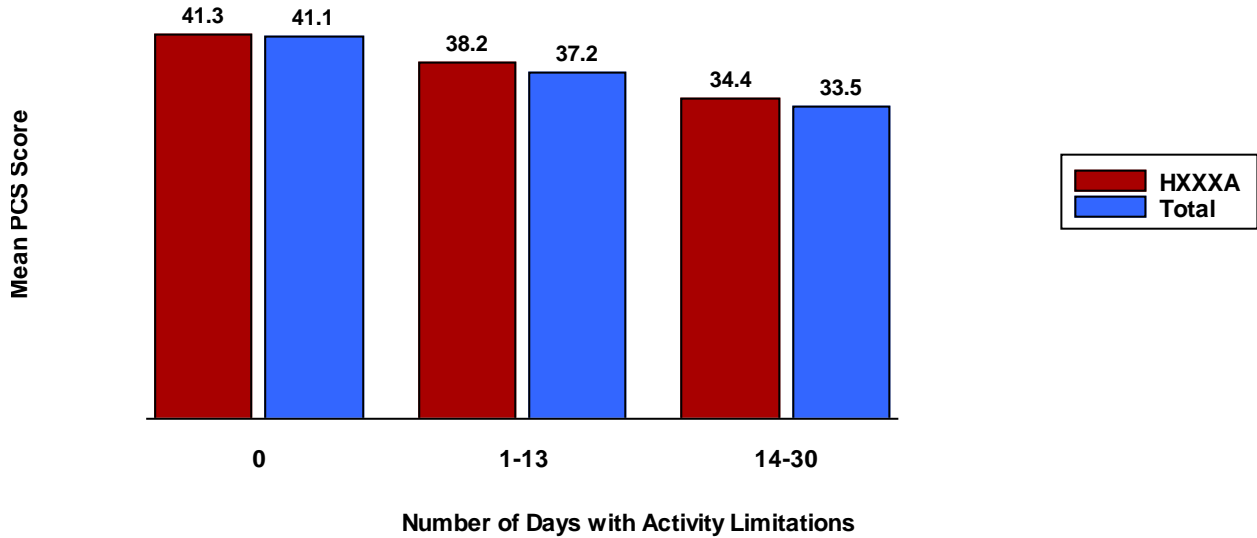
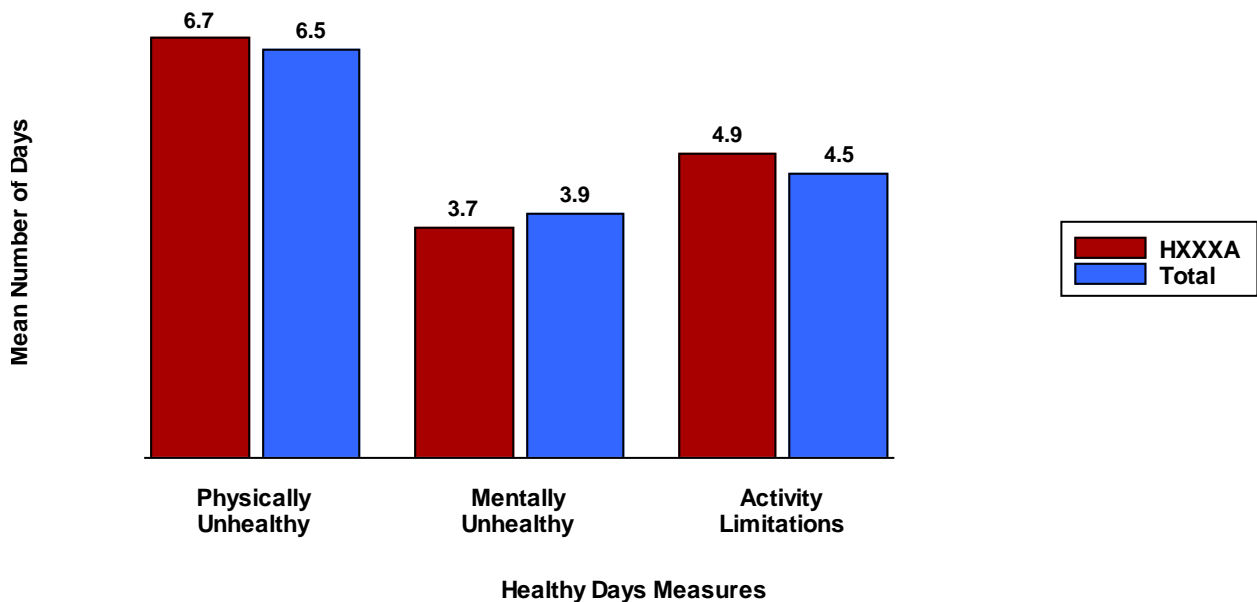

Figure 14 presents the mean numbers of reported physically unhealthy days, mentally unhealthy days, and days with activity limitations during the previous 30 days in MAO HXXXA and the HOS Total.

Figure 14: 2017 Cohort 20 Baseline Mean Number of Unhealthy Days for the Healthy Days Measures for MAO HXXXA and HOS Total



Body Mass Index

Definition of Measure

- Self-reported height and weight values are used to calculate BMI,^O a measure that correlates with the amount of body fat in adult men and women. BMI is derived from Questions 55 and 56.^P

A BMI of 30 or higher is considered obese and increases risk for several chronic conditions including: hypertension, dyslipidemia, type 2 diabetes, coronary heart disease, stroke, gallbladder disease, osteoarthritis, sleep apnea, and some cancers.⁴⁰ Being overweight (BMI 25-29.9) or obese has been shown to accelerate the aging process.⁴¹ Physical activity, diet, age, gender, ethnicity, and educational status are known to influence the risk for obesity.⁴² For instance, females are at higher risk of developing morbid obesity than males. The prevalence of obesity among older adults has risen significantly over the past 30 years.^{43,44} A BMI under 18.5 is considered underweight. Rapid weight loss often indicates an underlying disease and can accelerate the loss of muscle mass, which naturally occurs with the aging process.⁴⁵

A study using the HOS 2006-2008 Cohort 9 Merged Baseline and Follow Up data explored the prevalence of obesity in MA beneficiaries age 65 or older.⁷ In this study, most of the reported health conditions were significantly more prevalent among obese than normal weight beneficiaries, in particular, high blood pressure (75.8% of obese vs. 53.9% of normal weight), diabetes (34.8% vs. 12.7%), and arthritis of the hip or knee (55.3% vs. 31.3%). Exceptions were osteoporosis and stroke. Osteoporosis was significantly less prevalent among the obese (16.1% vs. 26.9%). The prevalence of stroke increased only slightly with BMI (7.9% vs 7.3%). The results also indicated that obese beneficiaries had substantially greater limitations with ADLs than normal weight beneficiaries.⁷

How Is Your MAO Doing?

Table 20 shows the distribution of BMI categories by gender including underweight (BMI less than 18.5), normal or healthy weight (BMI of 18.5-24.99), overweight (BMI of 25-29.99), and obese (BMI of 30 or more) for MAO HXXXXA and the HOS Total.

Table 20: 2017 Cohort 20 Baseline Distribution of BMI Categories by Gender for MAO HXXXXA and HOS Total

BMI Category	MAO HXXXXA		HOS Total	
	Male N (%)	Female N (%)	Male N (%)	Female N (%)
Underweight (<18.5)	0	6 (3.1%)	928 (1.3%)	2,535 (2.6%)
Normal (18.5-24.99)	30 (20.1%)	61 (31.8%)	18,270 (26.0%)	30,365 (31.2%)
Overweight (25-29.99)	66 (44.3%)	62 (32.3%)	30,260 (43.1%)	31,817 (32.6%)
Obese (≥30)	53 (35.6%)	63 (32.8%)	20,739 (29.5%)	32,754 (33.6%)

Note: BMI categories were modified beginning with this report. Underweight was changed from “<20” to “<18.5” and normal weight was changed from “20 to 24.99” to “18.5 to 24.99.”

^O BMI is calculated as: $BMI = [weight \text{ in pounds} / (height \text{ in inches})^2] \times 703$, which uses the height and weight to produce the standard measure of kg/m^2 units.

^P Beginning in 2012, questions for weight and height changed from categorical responses to open ended responses.

Table 21 presents the mean adjusted PCS and MCS scores by BMI categories for MAO HXXXXA and the HOS Total.

Table 21: 2017 Cohort 20 Baseline Mean Adjusted PCS and MCS Scores by BMI Categories for MAO HXXXXA and HOS Total

BMI Category	MAO HXXXXA		HOS Total	
	PCS Mean (SD)	MCS Mean (SD)	PCS Mean (SD)	MCS Mean (SD)
Underweight (<18.5)	37.7 (6.6)	50.3 (4.8)	38.0 (7.3)	51.7 (6.0)
Normal (18.5-24.99)	40.3 (7.4)	53.7 (5.3)	40.2 (7.4)	53.4 (5.7)
Overweight (25-29.99)	40.1 (6.9)	53.5 (5.8)	40.0 (7.2)	53.5 (5.7)
Obese (≥ 30)	38.5 (7.3)	51.9 (5.9)	37.9 (7.1)	52.4 (6.0)

Table 22 shows the mean number of chronic conditions by BMI categories for MAO HXXXXA and the HOS Total. Obesity exacerbates chronic conditions such as diabetes, hyperlipidemia, and hypertension, increasing medical costs and negatively affecting quality of life.^{46, 47}

Table 22: 2017 Cohort 20 Baseline Mean Number of Chronic Conditions by BMI Categories for MAO HXXXXA and HOS Total

BMI Category	MAO HXXXXA Number of Conditions Mean (SD)	HOS Total Number of Conditions Mean (SD)
Underweight (<18.5)	3.5 (1.9)	3.3 (2.4)
Normal (18.5-24.99)	2.7 (2.1)	2.9 (2.2)
Overweight (25-29.99)	3.1 (2.1)	3.2 (2.3)
Obese (≥ 30)	3.7 (2.3)	4.0 (2.4)

Sleep Measures

Definition of Measures

- Sleep duration is a self-reported measure of the average number of hours of actual sleep at night during the past month. The measure is found in Question 53.
- Sleep quality is a self-reported measure that rates the overall sleep quality during the past month. The measure is found in Question 54.

Two sleep questions that were new in the 2015 HOS 3.0 were drawn from the Pittsburgh Sleep Quality Index (PSQI). The questions focus on “habitual” (i.e., past month) sleep duration and quality, rather than past week measures, in order to capture more chronic sleep disturbances. The PSQI has a high test-retest reliability and good validity in patients with insomnia.⁴⁸

Over half of older adults suffer from symptoms of insomnia, a common problem related to aging.⁴⁹ Sleep disorders in the elderly can be caused by a number of factors, including medication, diseases, poor sleeping habits, and age-related changes in circadian sleep/wake regulation. There is substantial evidence linking insufficient sleep duration and poor sleep quality to mental and physical health morbidity and mortality.⁵⁰ Various epidemiologic findings associate sleep duration with obesity, diabetes, impaired glucose tolerance, hypertension, and mortality. People who report fair or poor health are less likely to overestimate sleep hours and report shorter sleep hours on average than those with better self-rated health.⁵¹ These observations provide a basis for future studies on weight control interventions and maintenance of daily routines in sleep habits to increase the quantity and quality of sleep.

How Is Your MAO Doing?

Table 23 provides frequency distributions of sleep duration (“less than 5,” “5–6,” “7–8,” and “9 or more hours”) and sleep quality (“Very good,” “Fairly good,” “Fairly bad,” and “Very bad”) for MAO HXXXA and the HOS Total.

Table 23: 2017 Cohort 20 Baseline Distributions of Sleep Duration and Quality for MAO HXXXA and HOS Total

Sleep Questions	MAO HXXXA N (%)	HOS Total N (%)
Hours of actual sleep		
Less than 5 hours	34 (9.2%)	14,843 (8.3%)
5-6 hours	129 (34.9%)	67,842 (38.0%)
7-8 hours	187 (50.5%)	84,848 (47.5%)
9 or more hours	20 (5.4%)	11,016 (6.2%)
Overall sleep quality		
Very Good	83 (22.3%)	44,571 (24.9%)
Fairly Good	223 (59.9%)	105,516 (58.9%)
Fairly Bad	55 (14.8%)	23,409 (13.1%)
Very Bad	11 (3.0%)	5,700 (3.2%)

Health Status by Baseline Demographic Groups for MAO HXXXXA

Evidence from several studies suggests the differences in health among Medicare eligible beneficiaries by age, gender, racial, and socioeconomic groups.^{52, 53, 54, 55, 56} The following tables show differences in health status by demographic categories, including potential disparities within your MAO, and comparisons of your MAO with the HOS Total. Groups are defined by the sub-categories for a demographic characteristic (e.g., the 65-69 age group or White race). Estimates for the MAO that are highlighted in red indicate groups worse off than their HOS counterparts.

Table 24: 2017 Cohort 20 Baseline Mean Adjusted PCS and MCS Scores by Selected Demographic Characteristics for MAO HXXXXA and HOS Total

HOS Demographic	Adjusted PCS		Adjusted MCS	
	MAO HXXXXA Mean (SD)*	HOS Total Mean (SD)	MAO HXXXXA Mean (SD)*	HOS Total Mean (SD)
Total	39.2 (6.9)	39.1 (7.1)	52.8 (5.5)	52.8 (5.7)
Age				
65-69	41.8 (6.6)	41.5 (7.0)	52.2 (6.0)	52.8 (6.0)
70-74	39.6 (7.2)	40.1 (6.7)	53.1 (5.9)	53.2 (5.7)
75-79	39.5 (6.0)	38.3 (6.6)	53.9 (5.0)	53.1 (5.5)
80-84	36.7 (5.4)	36.5 (6.4)	52.9 (4.6)	52.7 (5.5)
85+	33.0 (5.7)	34.1 (6.5)	51.6 (4.9)	51.9 (5.6)
Gender				
Male	41.1 (6.5)	40.2 (7.0)	53.9 (5.1)	53.5 (5.4)
Female	37.8 (6.9)	38.2 (7.1)	52.0 (5.7)	52.4 (5.9)
Race				
White	39.7 (7.0)	39.6 (7.1)	53.6 (5.4)	53.6 (5.6)
Black	35.8 (6.0)	36.3 (6.6)	49.7 (4.7)	50.7 (5.2)
Other/Unknown	40.8 (6.6)	38.5 (7.5)	51.0 (6.1)	50.0 (6.0)
Marital Status				
Married	40.6 (7.3)	41.0 (7.0)	54.0 (5.4)	54.2 (5.5)
Widowed	36.4 (6.6)	36.3 (7.1)	51.9 (5.3)	51.8 (5.9)
Divorced or Separated	39.0 (6.5)	38.3 (7.0)	51.2 (6.2)	51.6 (6.0)
Never Married	41.4 (6.4)	38.8 (6.9)	53.2 (5.7)	51.7 (5.8)
Education				
Did Not Graduate HS	35.2 (6.6)	35.1 (6.9)	49.1 (5.4)	49.3 (5.8)
High School Graduate	38.1 (6.1)	38.3 (6.7)	52.8 (4.9)	53.0 (5.5)
Some College	41.1 (7.2)	40.1 (6.7)	54.4 (5.5)	54.1 (5.6)
4 Year Degree or Beyond	43.2 (6.4)	43.5 (6.6)	55.2 (5.4)	55.2 (5.1)
Annual Household Income				
Less than \$10,000	35.0 (6.2)	34.8 (6.8)	48.9 (5.7)	49.0 (5.7)
\$10,000-\$19,999	37.8 (5.3)	36.2 (6.6)	51.5 (4.5)	50.9 (5.6)
\$20,000-\$29,999	38.1 (6.9)	38.5 (6.5)	52.5 (5.4)	53.0 (5.4)
\$30,000-\$49,999	40.9 (6.3)	41.1 (6.3)	54.4 (5.5)	54.8 (5.1)
\$50,000 or More	45.4 (5.9)	44.6 (6.2)	56.9 (4.5)	56.3 (4.6)
Don't Know	36.4 (6.2)	37.3 (6.5)	50.9 (4.9)	51.5 (5.7)
Medicaid Status				
Medicaid	35.2 (6.2)	35.0 (6.6)	49.1 (5.2)	49.1 (5.7)
Non-Medicaid	40.5 (6.7)	40.4 (6.8)	53.9 (5.1)	54.1 (5.2)

* Means for demographic groups in the MAO column(s) highlighted in red are lower by ten percent or more compared to the corresponding groups in the HOS Total column(s). In this report, estimates highlighted in red indicate groups worse off than their HOS Total counterparts.

Table 25: 2017 Cohort 20 Baseline Distribution of Self-Rated General Health Status, and Physical and Mental Health Status Compared to One Year Ago by Demographic Group for MAO HXXXA and HOS Total

HOS Demographic	General Health Status Fair or Poor		Comparative Health-Physical Slightly Worse or Much Worse		Comparative Health-Mental Slightly Worse or Much Worse	
	MAO HXXXA N (%)*	HOS Total N (%)	MAO HXXXA N (%)*	HOS Total N (%)	MAO HXXXA N (%)*	HOS Total N (%)
Total	112 (28.8%)	54,226 (28.9%)	116 (30.4%)	48,917 (26.7%)	52 (13.9%)	23,393 (13.0%)
Age						
65-69	33 (26.6%)	15,102 (27.0%)	35 (28.5%)	12,626 (23.0%)	20 (16.5%)	6,763 (12.5%)
70-74	27 (26.0%)	13,040 (25.4%)	32 (29.9%)	11,972 (23.9%)	12 (11.5%)	5,654 (11.5%)
75-79	17 (23.6%)	10,343 (28.5%)	19 (27.1%)	9,434 (26.7%)	5 (7.2%)	4,330 (12.5%)
80-84	14 (31.1%)	7,641 (32.3%)	14 (32.6%)	7,115 (31.0%)	7 (16.3%)	3,117 (13.8%)
85+	21 (47.7%)	8,100 (39.3%)	16 (41.0%)	7,770 (39.2%)	8 (21.1%)	3,529 (18.2%)
Gender						
Male	47 (28.5%)	21,217 (27.2%)	51 (31.5%)	19,594 (25.8%)	18 (11.3%)	8,988 (12.0%)
Female	65 (29.0%)	33,009 (30.1%)	65 (29.5%)	29,323 (27.4%)	34 (15.7%)	14,405 (13.7%)
Race						
White	75 (25.4%)	37,234 (25.5%)	92 (31.9%)	37,788 (26.6%)	41 (14.5%)	17,404 (12.4%)
Black	28 (48.3%)	9,385 (41.5%)	19 (31.7%)	5,780 (26.3%)	9 (15.3%)	2,935 (13.7%)
Other/Unknown	9 (25.0%)	7,607 (39.0%)	5 (14.7%)	5,349 (28.5%)	2 (5.9%)	3,054 (16.4%)
Marital Status						
Married	42 (22.3%)	20,490 (22.7%)	44 (23.4%)	21,242 (23.7%)	15 (8.1%)	9,577 (10.8%)
Widowed	28 (37.3%)	14,751 (34.3%)	26 (34.7%)	13,194 (30.9%)	10 (13.5%)	6,427 (15.3%)
Divorced or Separated	23 (31.1%)	11,231 (33.2%)	29 (38.7%)	9,771 (29.1%)	16 (22.2%)	4,960 (15.0%)
Never Married	8 (32.0%)	3,516 (34.5%)	10 (43.5%)	2,630 (26.0%)	5 (20.8%)	1,300 (13.0%)
Education						
Did Not Graduate HS	39 (52.7%)	17,759 (49.6%)	29 (39.7%)	11,692 (32.9%)	12 (16.4%)	6,292 (17.9%)
High School Graduate	27 (26.2%)	15,733 (28.8%)	31 (29.8%)	14,669 (27.0%)	11 (11.2%)	6,819 (12.8%)
Some College	17 (18.7%)	9,739 (21.8%)	28 (31.1%)	11,241 (25.4%)	11 (12.2%)	5,117 (11.7%)
4 Year Degree or Beyond	15 (17.0%)	5,643 (14.0%)	22 (24.7%)	8,746 (21.8%)	12 (13.5%)	3,715 (9.4%)
Annual Household Income						
Less than \$10,000	25 (47.2%)	11,310 (48.3%)	19 (36.5%)	8,061 (34.6%)	10 (19.2%)	4,379 (19.1%)
\$10,000-\$19,999	17 (28.8%)	10,918 (38.1%)	16 (28.6%)	9,349 (32.8%)	7 (12.7%)	4,703 (16.7%)
\$20,000-\$29,999	14 (31.8%)	6,392 (27.4%)	13 (29.5%)	6,554 (28.3%)	6 (14.0%)	3,012 (13.2%)
\$30,000-\$49,999	11 (20.0%)	5,771 (18.6%)	23 (41.1%)	7,205 (23.4%)	7 (12.7%)	3,141 (10.3%)
\$50,000 or More	9 (11.1%)	4,032 (10.8%)	17 (20.7%)	7,012 (19.0%)	5 (6.2%)	2,816 (7.7%)
Don't Know	17 (36.2%)	8,117 (38.8%)	15 (32.6%)	5,752 (27.7%)	6 (13.6%)	2,941 (14.4%)
Medicaid Status						
Medicaid	48 (50.0%)	24,330 (52.2%)	35 (38.0%)	16,282 (36.2%)	21 (23.3%)	8,974 (20.2%)
Non-Medicaid	64 (21.8%)	29,886 (21.2%)	81 (27.9%)	32,628 (23.7%)	31 (10.9%)	14,415 (10.6%)

* Percentages for demographic groups in the MAO column(s) highlighted in red are greater by ten percentage points or more compared to corresponding groups in the HOS Total column(s). In this report, estimates highlighted in red indicate groups worse off than their HOS Total counterparts.

Table 26: 2017 Cohort 20 Baseline Distribution of Positive Depression Screen by Demographic Group for MAO HXXXA and HOS Total

HOS Demographic	MAO HXXXA Positive Screen N (%)*	HOS Total Positive Screen N (%)
Total	49 (13.4%)	23,707 (13.5%)
Age		
65-69	26 (21.0%)	7,089 (13.4%)
70-74	8 (7.6%)	5,787 (12.0%)
75-79	7 (10.8%)	4,179 (12.3%)
80-84	3 (7.9%)	3,057 (14.0%)
85+	5 (14.3%)	3,595 (19.2%)
Gender		
Male	20 (12.8%)	8,923 (12.2%)
Female	29 (13.7%)	14,784 (14.4%)
Race		
White	29 (10.4%)	15,923 (11.6%)
Black	13 (24.5%)	4,373 (21.2%)
Other/Unknown	7 (20.6%)	3,411 (19.1%)
Marital Status		
Married	19 (10.1%)	8,742 (9.9%)
Widowed	11 (15.9%)	7,055 (17.0%)
Divorced or Separated	15 (20.3%)	5,626 (17.2%)
Never Married	3 (13.0%)	1,578 (16.1%)
Education		
Did Not Graduate HS	17 (23.9%)	8,475 (24.7%)
High School Graduate	12 (11.9%)	7,049 (13.3%)
Some College	11 (12.1%)	4,443 (10.2%)
4 Year Degree or Beyond	4 (4.6%)	2,446 (6.2%)
Annual Household Income		
Less than \$10,000	13 (25.5%)	5,758 (25.5%)
\$10,000-\$19,999	6 (10.3%)	5,081 (18.2%)
\$20,000-\$29,999	3 (6.8%)	2,902 (12.7%)
\$30,000-\$49,999	4 (7.4%)	2,333 (7.7%)
\$50,000 or More	4 (4.9%)	1,538 (4.2%)
Don't Know	11 (26.8%)	3,992 (20.1%)
Medicaid Status		
Medicaid	29 (33.3%)	11,502 (27.1%)
Non-Medicaid	20 (7.1%)	12,201 (9.1%)

* Percentages for demographic groups in the MAO column highlighted in red are greater by ten percentage points or more compared to the corresponding groups in the HOS Total column. In this report, estimates highlighted in red indicate groups worse off than their HOS Total counterparts.

Table 27: 2017 Cohort 20 Baseline Distribution of Pain Interfering with Daily Activities and Socializing by Demographic Group for MAO HXXXA and HOS Total

HOS Demographic	Pain Interfering with Daily Activities Quite a Bit or Very Much		Pain Limiting Socialization Often or Always	
	MAO HXXXA N (%)*	HOS Total N (%)	MAO HXXXA N (%)*	HOS Total N (%)
Total	63 (17.0%)	30,886 (17.1%)	35 (9.4%)	16,983 (9.4%)
Age				
65-69	22 (18.0%)	9,462 (17.5%)	19 (15.4%)	5,402 (10.0%)
70-74	17 (16.3%)	7,678 (15.5%)	6 (5.8%)	4,112 (8.3%)
75-79	8 (11.9%)	5,648 (16.2%)	5 (7.4%)	3,010 (8.6%)
80-84	7 (17.5%)	4,021 (17.8%)	2 (4.9%)	2,043 (9.1%)
85+	9 (23.7%)	4,077 (21.0%)	3 (8.1%)	2,416 (12.5%)
Gender				
Male	24 (15.2%)	10,615 (14.1%)	11 (6.9%)	5,725 (7.6%)
Female	39 (18.3%)	20,271 (19.2%)	24 (11.3%)	11,258 (10.7%)
Race				
White	41 (14.6%)	21,875 (15.5%)	19 (6.8%)	11,497 (8.2%)
Black	16 (29.1%)	5,297 (24.6%)	9 (15.8%)	2,906 (13.6%)
Other/Unknown	6 (17.1%)	3,714 (20.2%)	7 (20.6%)	2,580 (14.0%)
Marital Status				
Married	31 (16.4%)	11,834 (13.2%)	13 (6.9%)	5,981 (6.7%)
Widowed	15 (20.5%)	8,951 (20.9%)	7 (9.6%)	5,017 (11.8%)
Divorced or Separated	11 (15.3%)	7,321 (21.8%)	13 (17.6%)	4,338 (12.9%)
Never Married	3 (12.0%)	1,870 (18.4%)	2 (8.0%)	1,096 (10.8%)
Education				
Did Not Graduate HS	19 (25.3%)	9,929 (27.9%)	13 (17.6%)	5,930 (16.7%)
High School Graduate	19 (18.8%)	9,319 (17.1%)	9 (8.9%)	4,909 (9.0%)
Some College	11 (12.5%)	6,719 (15.1%)	5 (5.6%)	3,493 (7.9%)
4 Year Degree or Beyond	10 (11.4%)	3,519 (8.8%)	5 (5.7%)	1,730 (4.3%)
Annual Household Income				
Less than \$10,000	13 (25.0%)	6,998 (30.0%)	9 (17.3%)	4,376 (18.8%)
\$10,000-\$19,999	7 (12.3%)	6,696 (23.5%)	5 (8.8%)	3,817 (13.4%)
\$20,000-\$29,999	7 (15.9%)	3,946 (17.0%)	2 (4.5%)	2,007 (8.7%)
\$30,000-\$49,999	14 (25.9%)	3,564 (11.6%)	4 (7.1%)	1,622 (5.3%)
\$50,000 or More	4 (4.9%)	2,568 (6.9%)	1 (1.3%)	1,069 (2.9%)
Don't Know	11 (22.9%)	4,402 (21.1%)	8 (17.4%)	2,572 (12.4%)
Medicaid Status				
Medicaid	29 (31.9%)	13,998 (31.7%)	22 (23.9%)	8,838 (20.1%)
Non-Medicaid	34 (12.1%)	16,881 (12.4%)	13 (4.6%)	8,139 (6.0%)

* Percentages for demographic groups in the MAO column(s) highlighted in **red** are greater by ten percentage points or more compared to the corresponding groups in the HOS Total column(s). In this report, estimates highlighted in **red** indicate groups worse off than their HOS Total counterparts.

Table 28: 2017 Cohort 20 Baseline Distribution of Beneficiaries Reporting Multiple Chronic Medical Conditions[§] in MAO HXXXXA and HOS Total

HOS Demographic	MAO HXXXXA Multiple Conditions [§] N (%) [*]	HOS Total Multiple Conditions [§] N (%)
Total	289 (76.3%)	140,840 (76.8%)
Age		
65-69	90 (71.4%)	39,525 (72.1%)
70-74	82 (78.8%)	38,273 (76.2%)
75-79	51 (75.0%)	28,108 (79.2%)
80-84	36 (85.7%)	18,649 (81.2%)
85+	30 (76.9%)	16,285 (82.0%)
Gender		
Male	116 (72.0%)	55,408 (72.8%)
Female	173 (79.4%)	85,432 (79.7%)
Race		
White	212 (73.9%)	108,788 (76.3%)
Black	52 (91.2%)	17,998 (82.2%)
Other/Unknown	25 (71.4%)	14,054 (74.4%)
Marital Status		
Married	145 (76.3%)	66,823 (73.7%)
Widowed	63 (84.0%)	35,626 (82.1%)
Divorced or Separated	56 (75.7%)	26,995 (79.4%)
Never Married	15 (60.0%)	7,822 (76.2%)
Education		
Did Not Graduate HS	63 (82.9%)	29,961 (82.7%)
High School Graduate	78 (76.5%)	42,907 (78.1%)
Some College	70 (77.8%)	34,553 (77.2%)
4 Year Degree or Beyond	62 (68.9%)	28,368 (70.0%)
Annual Household Income		
Less than \$10,000	43 (82.7%)	19,665 (83.1%)
\$10,000-\$19,999	43 (74.1%)	23,792 (82.6%)
\$20,000-\$29,999	35 (79.5%)	18,561 (79.4%)
\$30,000-\$49,999	44 (77.2%)	23,372 (75.2%)
\$50,000 or More	56 (69.1%)	25,895 (69.5%)
Don't Know	40 (83.3%)	16,598 (78.1%)
Medicaid Status		
Medicaid	78 (84.8%)	38,233 (84.8%)
Non-Medicaid	211 (73.5%)	102,582 (74.2%)

[§] Multiple chronic medical conditions are defined as having two or more conditions.

^{*} Percentages for demographic groups in the MAO column highlighted in **red** are greater by ten percentage points or more compared to the corresponding groups in the HOS Total column. In this report, estimates highlighted in **red** indicate groups worse off than their HOS Total counterparts.

Table 29: 2017 Cohort 20 Baseline Distribution of Multiple ADL Impairments[§] by Demographic Group for MAO HXXXXA and HOS Total

HOS Demographic	MAO HXXXXA ADL Impairments [§] N (%) [*]	HOS Total ADL Impairments [§] N (%)
Total	97 (25.2%)	44,264 (24.0%)
Age		
65-69	30 (24.0%)	10,555 (19.2%)
70-74	21 (19.4%)	9,738 (19.4%)
75-79	16 (22.9%)	8,173 (22.9%)
80-84	12 (28.6%)	6,897 (29.8%)
85+	18 (45.0%)	8,901 (44.5%)
Gender		
Male	35 (21.5%)	16,092 (21.1%)
Female	62 (27.9%)	28,172 (26.1%)
Race		
White	64 (22.1%)	31,958 (22.4%)
Black	22 (36.7%)	7,083 (32.0%)
Other/Unknown	11 (31.4%)	5,223 (27.5%)
Marital Status		
Married	39 (20.5%)	16,338 (18.1%)
Widowed	27 (36.0%)	13,994 (32.4%)
Divorced or Separated	21 (28.0%)	9,096 (26.9%)
Never Married	5 (20.8%)	2,959 (29.0%)
Education		
Did Not Graduate HS	28 (37.3%)	12,852 (35.7%)
High School Graduate	25 (24.3%)	13,594 (24.9%)
Some College	22 (23.9%)	9,486 (21.3%)
4 Year Degree or Beyond	14 (15.7%)	5,807 (14.4%)
Annual Household Income		
Less than \$10,000	18 (34.6%)	9,101 (38.7%)
\$10,000-\$19,999	12 (21.1%)	9,400 (32.8%)
\$20,000-\$29,999	12 (27.3%)	5,770 (24.8%)
\$30,000-\$49,999	18 (32.1%)	5,497 (17.8%)
\$50,000 or More	10 (12.2%)	4,098 (11.1%)
Don't Know	14 (29.2%)	5,915 (28.0%)
Medicaid Status		
Medicaid	40 (43.5%)	19,345 (42.4%)
Non-Medicaid	57 (19.5%)	24,910 (18.0%)

§ Multiple ADL impairments are defined as having two or more impairments.

* Percentages for demographic groups in the MAO column highlighted in **red** are greater by ten percentage points or more compared to the corresponding groups in the HOS Total column. In this report, estimates highlighted in **red** indicate groups worse off than their HOS Total counterparts.

Table 30: 2017 Cohort 20 Baseline Mean Number of Unhealthy Physical, Mental, and Activity Limitation Days by Demographic Group in MAO HXXXA and HOS Total

HOS Demographic	MAO HXXXA			HOS Total		
	Number of Unhealthy Days			Number of Unhealthy Days		
	Physical Mean (SD)*	Mental Mean (SD)*	Activity Mean (SD)*	Physical Mean (SD)	Mental Mean (SD)	Activity Mean (SD)
Total	6.7 (10.4)	3.7 (7.9)	4.9 (9.1)	6.5 (10.0)	3.9 (7.9)	4.5 (8.9)
Age						
65-69	7.4 (10.9)	5.2 (9.6)	5.6 (10.0)	6.3 (9.8)	4.1 (8.0)	4.4 (8.5)
70-74	7.0 (11.0)	2.7 (7.0)	4.1 (8.1)	5.9 (9.5)	3.5 (7.5)	3.9 (8.2)
75-79	4.0 (7.6)	1.7 (5.0)	2.6 (6.4)	6.2 (9.8)	3.5 (7.5)	4.2 (8.5)
80-84	5.1 (7.5)	3.3 (6.9)	5.2 (9.1)	7.0 (10.4)	3.8 (7.9)	4.9 (9.3)
85+	10.4 (12.5)	5.1 (8.3)	8.2 (11.5)	8.7 (11.3)	5.1 (9.0)	6.7 (10.9)
Gender						
Male	6.8 (10.9)	3.1 (7.4)	5.1 (9.7)	6.0 (9.8)	3.4 (7.5)	4.1 (8.6)
Female	6.6 (10.0)	4.1 (8.2)	4.7 (8.6)	6.9 (10.1)	4.3 (8.1)	4.8 (9.0)
Race						
White	6.6 (10.4)	3.1 (7.2)	4.5 (8.8)	6.3 (9.9)	3.7 (7.6)	4.3 (8.7)
Black	7.3 (10.5)	6.0 (10.3)	6.8 (10.2)	7.9 (10.3)	4.9 (8.7)	5.5 (9.4)
Other/Unknown	6.3 (10.5)	4.9 (9.0)	5.2 (9.3)	7.1 (10.1)	4.7 (8.7)	5.2 (9.4)
Marital Status						
Married	6.0 (10.3)	2.3 (6.2)	4.4 (9.0)	5.5 (9.4)	3.0 (7.0)	3.7 (8.1)
Widowed	7.7 (10.9)	4.5 (8.6)	5.2 (9.2)	7.5 (10.5)	4.6 (8.5)	5.4 (9.6)
Divorced or Separated	7.3 (10.3)	5.5 (9.2)	5.3 (8.9)	7.7 (10.4)	4.9 (8.6)	5.5 (9.3)
Never Married	7.5 (10.0)	6.9 (10.6)	4.5 (7.8)	7.1 (10.2)	4.7 (8.6)	5.2 (9.3)
Education						
Did Not Graduate HS	8.5 (11.3)	6.9 (10.8)	8.0 (10.5)	9.0 (11.0)	5.9 (9.5)	6.7 (10.4)
High School Graduate	7.6 (10.6)	3.4 (7.4)	4.3 (8.7)	6.7 (10.1)	3.9 (7.9)	4.5 (8.9)
Some College	5.9 (9.9)	3.0 (6.9)	4.5 (9.0)	6.2 (9.7)	3.5 (7.3)	4.1 (8.4)
4 Year Degree or Beyond	4.8 (9.4)	2.1 (5.5)	3.0 (7.3)	4.4 (8.5)	2.4 (6.1)	2.9 (7.1)
Annual Household Income						
Less than \$10,000	8.2 (10.6)	7.4 (11.4)	7.3 (10.7)	9.6 (11.0)	6.5 (9.7)	7.3 (10.5)
\$10,000-\$19,999	6.6 (10.6)	3.9 (8.3)	3.7 (7.7)	8.5 (10.8)	5.3 (8.9)	6.2 (9.9)
\$20,000-\$29,999	6.6 (9.7)	2.5 (6.1)	5.3 (8.8)	6.8 (10.1)	4.0 (7.8)	4.7 (8.9)
\$30,000-\$49,999	9.0 (12.2)	2.9 (6.9)	5.7 (10.3)	5.3 (9.2)	2.9 (6.7)	3.4 (7.8)
\$50,000 or More	3.2 (7.2)	1.4 (3.7)	2.0 (5.9)	3.7 (7.8)	1.9 (5.4)	2.3 (6.4)
Don't Know	7.3 (11.0)	5.1 (8.6)	5.4 (9.3)	7.4 (10.5)	4.6 (8.7)	5.2 (9.5)
Medicaid Status						
Medicaid	10.1 (11.2)	8.5 (11.6)	9.4 (11.4)	10.3 (11.3)	6.9 (10.0)	8.1 (10.9)
Non-Medicaid	5.7 (9.9)	2.3 (5.7)	3.5 (7.8)	5.3 (9.2)	3.0 (6.8)	3.4 (7.8)

* Means for demographic groups in the MAO column(s) highlighted in **red** are greater by ten percent or more compared to the corresponding groups in the HOS Total column(s). In this report, estimates highlighted in **red** indicate groups worse off than their HOS Total counterparts.

Table 31: 2017 Cohort 20 Baseline Distribution of BMI Categories by Demographic Group for MAO HXXXA and HOS Total

HOS Demographic	MAO HXXXA		HOS Total	
	Underweight (<18.5 BMI) N (%)*	Obese (≥30 BMI) N (%)*	Underweight (<18.5 BMI) N (%)	Obese (≥30 BMI) N (%)
Total	6 (1.8%)	116 (34.0%)	3,463 (2.1%)	53,493 (31.9%)
Age				
65-69	2 (1.8%)	47 (42.3%)	834 (1.6%)	19,422 (37.9%)
70-74	2 (2.0%)	35 (35.7%)	748 (1.6%)	16,192 (34.9%)
75-79	1 (1.6%)	21 (33.3%)	613 (1.9%)	9,860 (30.5%)
80-84	0	6 (17.1%)	514 (2.5%)	5,067 (24.7%)
85+	1 (2.9%)	7 (20.6%)	754 (4.4%)	2,952 (17.1%)
Gender				
Male	0	53 (35.6%)	928 (1.3%)	20,739 (29.5%)
Female	6 (3.1%)	63 (32.8%)	2,535 (2.6%)	32,754 (33.6%)
Race				
White	5 (1.9%)	78 (30.2%)	2,526 (1.9%)	41,614 (31.5%)
Black	0	24 (46.2%)	432 (2.2%)	8,006 (41.5%)
Other/Unknown	1 (3.2%)	14 (45.2%)	505 (3.1%)	3,873 (23.6%)
Marital Status				
Married	2 (1.2%)	59 (34.1%)	1,268 (1.5%)	26,030 (30.6%)
Widowed	2 (2.9%)	21 (30.0%)	1,143 (2.9%)	12,420 (31.2%)
Divorced or Separated	2 (2.7%)	30 (41.1%)	722 (2.3%)	11,158 (35.1%)
Never Married	0	6 (25.0%)	272 (2.9%)	3,325 (35.4%)
Education				
Did Not Graduate HS	2 (3.1%)	29 (44.6%)	860 (2.7%)	11,134 (34.5%)
High School Graduate	3 (3.1%)	34 (35.4%)	1,111 (2.2%)	17,337 (34.0%)
Some College	0	29 (33.3%)	750 (1.8%)	14,334 (33.8%)
4 Year Degree or Beyond	1 (1.2%)	21 (24.4%)	655 (1.7%)	9,695 (24.9%)
Annual Household Income				
Less than \$10,000	2 (4.1%)	21 (42.9%)	644 (3.0%)	7,513 (35.1%)
\$10,000-\$19,999	1 (1.9%)	23 (42.6%)	649 (2.4%)	9,259 (34.6%)
\$20,000-\$29,999	1 (2.3%)	8 (18.2%)	394 (1.8%)	7,525 (34.2%)
\$30,000-\$49,999	0	12 (25.5%)	455 (1.5%)	9,444 (31.9%)
\$50,000 or More	1 (1.3%)	21 (27.3%)	455 (1.3%)	9,984 (27.8%)
Don't Know	1 (2.4%)	20 (47.6%)	563 (3.0%)	5,965 (31.6%)
Medicaid Status				
Medicaid	3 (3.5%)	40 (46.5%)	1,217 (3.1%)	14,369 (36.4%)
Non-Medicaid	3 (1.2%)	76 (29.8%)	2,244 (1.8%)	39,116 (30.5%)

* Percentages for demographic groups within the MAO column(s) highlighted in **red** are greater by ten percentage points or more compared to the corresponding groups in the HOS Total column(s). In this report, estimates highlighted in **red** indicate groups worse off than their HOS Total counterparts.

2017 NCQA HEDIS Measures

Four Effectiveness of Care measures from the Healthcare Effectiveness Data and Information Set (HEDIS) were included in the 2017 Medicare HOS: *Management of Urinary Incontinence in Older Adults* (MUI), *Physical Activity in Older Adults* (PAO), *Fall Risk Management* (FRM), and *Osteoporosis Testing in Older Women* (OTO). The results for the HEDIS measures are calculated by NCQA using data collected in the combined baseline and follow up survey samples from the same measurement year; i.e., a round of data. For the 2017 measurement year, the round of data (*Cohort 20 Baseline* and *Cohort 18 Follow Up* data) are combined. *Please note that for all other sections of this report, only the 2017 Cohort 20 Baseline sample is used.*

For each of the HEDIS measures, the MAO’s rate may or may not be reported depending on the denominator size. There must be at least 100 responses in the denominator for the MAO to obtain a reportable result for each rate. If there were fewer than 100 responses in the denominator, NCQA assigned a result of *not applicable* (NA) for the rate. For additional HEDIS measure results, please refer to the NCQA HEDIS Measures Table in the Executive Summary section.

The HEDIS summary table below presents the numerators, denominators, and percentages for the HEDIS measure results for your MAO. The subsequent pages present specific information on the relevance and calculations for each of the measures, as well as the aggregated mean rates for the state, CMS Region, and HOS Total. For a list of the states within each CMS Region, visit www.cms.gov/About-CMS/Agency-Information/RegionalOffices/.

For the 2017 NCQA HEDIS measures, members with evidence from CMS administrative records of a hospice start date or hospice enrollment are excluded from the HEDIS measure calculations. For detailed information about the NCQA HEDIS measures, please refer to the HEDIS 2017 Volume 6, Specifications for the Medicare Health Outcomes Survey Manual.⁹

Table 32: 2017 NCQA HEDIS Performance Measures for MAO HXXXXA

HEDIS Measure	Numerator	Denominator	Percentage
MUI			
Discussing Urinary Incontinence	116	198	58.59%
Treatment of Urinary Incontinence*	90	198	45.45%
Impact of Urinary Incontinence	28	202	13.86%
PAO			
Discussing Physical Activity	318	542	58.67%
Advising Physical Activity*	280	545	51.38%
FRM			
Discussing Fall Risk	124	367	33.79%
Managing Fall Risk*	129	228	56.58%
OTO			
Osteoporosis Testing in Older Women	229	292	78.42%

* Measures incorporated into the 2019 Medicare Star Ratings include the MAO 2017 Improving Bladder Control (MUI Treat Rate), Monitoring Physical Activity (PAO Advise Rate) and Reducing the Risk of Falling (FRM Manage Rate).

Values are provided to the second decimal place for the Star Ratings. HEDIS names are abbreviated in this table. If the denominator for the MAO was less than 100 responses, NCQA assigned a result of *not applicable* (NA).

Management of Urinary Incontinence in Older Adults

HEDIS Measure

The *Management of Urinary Incontinence in Older Adults* (MUI) measure is comprised of four questions to gather data on leakage of urine, also called urinary incontinence (UI), UI interference with daily activities and sleep, patient/provider discussion of UI, and patient/provider discussion of UI treatment options. The questions were revised in 2015 to include all adults with UI in the *Discussing Urinary Incontinence* and *Treatment of Urinary Incontinence* denominators; and the *Treatment of Urinary Incontinence* numerator now assesses whether treatment options are discussed (vs. received). The *Impact of Urinary Incontinence* indicator was added to assess the impact of UI on daily activities and sleep. Changes in 2017 include the addition of a hospice exclusion:

- Members with evidence from CMS administrative records of a hospice start date or hospice enrollment are excluded.

The following components of this measure assess different facets of managing urinary incontinence in older adults:

Discussing Urinary Incontinence

The percentage of Medicare members 65 years of age and older who reported having urinary incontinence in the past six months and who discussed their incontinence with a health care provider.

Denominator Member response choices must be as follows to be included in the denominator:

Q42 = “Yes.”

Q44 = “Yes” or “No.”

Numerator Member response choices must be as follows to be included in the numerator:

Q44 = “Yes.”

Treatment of Urinary Incontinence

The percentage of Medicare members 65 years of age and older who reported having any urinary incontinence in the past six months and who discussed treatment options for their urinary incontinence with a health care provider.

Denominator Member response choices must be as follows to be included in the denominator:

Q42 = “Yes.”

Q45 = “Yes” or “No.”

Numerator Member response choices must be as follows to be included in the numerator:

Q45 = “Yes.”

Impact of Urinary Incontinence

The percentage of Medicare members 65 years of age and older who reported having any urinary incontinence in the past six months and who reported that urine leakage made them change their daily activities or interfered with their sleep a lot.

Note: A lower rate indicates better performance for this indicator.

Denominator Member response choices must be as follows to be included in the denominator:

Q42 = “Yes.”

Q43 = “A lot” or “Somewhat” or “Not at all”

Numerator Member response choices must be as follows to be included in the numerator:

Q43 = “A lot”

HOS Total Results

Table 33: Discussing Urinary Incontinence Rate for STXXXX, CMS Region XX and HOS Total

	Mean	SD	P10	P25	Median	P75	P90	Min	Max
StateXX	59.18	0.80	58.11	58.59	59.47	59.74	60.00	58.11	60.00
CMS Region XX	58.68	1.05	57.04	58.11	58.75	59.47	59.87	56.74	60.00
HOS Total	59.33	5.96	52.74	55.46	58.72	62.15	66.10	43.95	85.27

Note: If there was only one MAO in the state, the standard deviation (SD) for the state was *not calculated* (NC); and the 10th (P10), the 25th (P25), 50th (Median), 75th (P75), and 90th (P90) percentiles, and minimum and maximum rates will equal the MAO's rate. If the number of responses in the denominator for the MAO rate was less than 100, the HEDIS rate was *not applicable* (NA). If the rates for all MAOs in a state were NA, the HEDIS rate was also NA for the state. Statistics for State and Region were *not applicable* (NA) for Regional Preferred Provider Organizations (RPPO) and Private Fee-for-Service (PFFS) plans.

Table 34: Treatment of Urinary Incontinence Rate for STXXXX, CMS Region XX and HOS Total

	Mean	SD	P10	P25	Median	P75	P90	Min	Max
StateXX	44.99	0.57	44.14	44.81	44.97	45.45	45.56	44.14	45.56
CMS Region XX	44.84	0.72	43.75	44.14	45.00	45.45	45.51	43.50	45.56
HOS Total	45.44	4.93	39.45	42.02	45.20	48.75	51.64	31.37	57.63

Please see the note accompanying HEDIS Table 33 above for the meaning of NC and NA.

Table 35: Impact of Urinary Incontinence Rate for STXXXX, CMS Region XX and HOS Total

	Mean	SD	P10	P25	Median	P75	P90	Min	Max
StateXX	14.92	1.01	13.78	13.86	15.52	15.63	15.82	13.78	15.82
CMS Region XX	14.79	0.77	13.82	13.89	14.84	15.52	15.72	13.78	15.82
HOS Total	15.88	7.77	8.65	10.93	13.79	18.75	25.57	3.92	49.64

Please see the note accompanying HEDIS Table 33 above for the meaning of NC and NA.

Why Is It Important?

UI may cause a wide range of morbidities, including cellulitis, pressure ulcers, urinary tract infections, falls with fractures, sleep deprivation, social withdrawal, depression, and sexual dysfunction.^{57, 58} Persons with UI are not often being asked about their UI by a health care professional.⁵⁹ Consequently, UI remains significantly underreported and underdiagnosed.⁶⁰

Risk Factors

Women are most likely to develop incontinence during pregnancy and childbirth, or after the hormonal changes of menopause. Older men may become incontinent as a result of bladder obstruction or prostate surgery. Pelvic trauma, spinal cord damage, decreased mobility, cognitive impairment, and some medications can contribute to episodes of UI.^{57, 61}

Treatment

Evidence in the literature shows that treatment may reduce or eliminate UI in most patients. Effective treatments include behavioral therapies such as bladder training and techniques for pelvic muscle rehabilitation.⁶² Low-intensity behavioral therapies are ideal first-line interventions that are inexpensive, low risk, and can be initiated effectively by primary care providers. Pharmacologic therapies include anticholinergic agents and tricyclic anti-depressants, and surgical therapies include injections with bulking agents, and sling procedures.^{57, 58, 61}

Physical Activity in Older Adults

HEDIS Measure

The *Physical Activity in Older Adults* (PAO) measure is comprised of two questions to gather data on a patient's discussion of physical activity with a doctor or other health provider. Changes in 2017 include the addition of a hospice exclusion:

- Members with evidence from CMS administrative records of a hospice start date or hospice enrollment are excluded.

The following components of this measure assess different facets of promoting physical activity in older adults:

Discussing Physical Activity

The percentage of Medicare members 65 years of age and older who had a doctor's visit in the past 12 months and who spoke with a doctor or other health provider about their level of exercise or physical activity.

Denominator Member response choices must be as follows to be included in the denominator:

Q46 = "Yes" or "No."

Numerator Member response choices must be as follows to be included in the numerator:

Q46 = "Yes."

Advising Physical Activity

The percentage of Medicare members 65 years of age and older who had a doctor's visit in the past 12 months and who received advice to start, increase, or maintain their level of exercise or physical activity.

Note: Beneficiaries who respond to Q46, "I had no visits in the past 12 months," are excluded from results calculation for Q47.

Denominator Member response choices must be as follows to be included in the denominator:

Q47 = "Yes" or "No."

Numerator Member response choices must be as follows to be included in the numerator:

Q47 = "Yes."

HOS Total Results

Table 36: Discussing Physical Activity Rate for STXXXX, CMS Region XX and HOS Total

	Mean	SD	P10	P25	Median	P75	P90	Min	Max
StateXX	56.57	1.95	53.67	55.83	56.79	57.89	58.67	53.67	58.67
CMS Region XX	57.08	1.76	54.75	56.38	56.87	57.96	59.44	53.67	60.20
HOS Total	55.70	6.92	46.63	50.87	55.67	60.24	64.64	38.94	81.08

Please see the note accompanying HEDIS Table 33 for the meaning of NC and NA.

Table 37: Advising Physical Activity Rate for STXXXX, CMS Region XX and HOS Total

	Mean	SD	P10	P25	Median	P75	P90	Min	Max
StateXX	50.87	0.98	49.33	50.74	50.94	51.38	51.96	49.33	51.96
CMS Region XX	51.45	1.36	50.03	50.74	51.06	51.96	53.67	49.33	54.08
HOS Total	51.74	5.65	44.53	47.87	52.21	55.31	58.97	34.50	71.76

Please see the note accompanying HEDIS Table 33 for the meaning of NC and NA.

Why Is It Important?

Engaging in physical activity is more influential than genetic factors in avoiding the deterioration issues that come with aging.⁶³ In community-dwelling older people, exercise reduces the impact of age on mortality and confers the greatest benefits to improvements in the health status of the frail elderly.^{64, 65} Regular physical activity is associated with decreased risk for heart disease, hypertension, diabetes, certain cancers, arthritis, high cholesterol, osteoporosis, and premature mortality.^{18, 66} Lack of physical activity and poor diet are the major causes of obesity. The annual healthcare costs for obesity were estimated at \$147 billion as of 2008.⁶⁷ Physical activity also improves muscle strength and balance, reducing the risk of falls. Fall-related injuries are projected to cost the nation more than \$32.4 billion by the year 2020.⁶⁸ Regular physical activity improves physical functioning, fosters a sense of well-being, reduces fall risk, and reduces risk of depressive symptoms and anxiety.^{69, 70, 71, 72}

Risk Factors

Physical activity decreases with increasing age. Of those age 65-74 years, approximately 25% participate in regular leisure time physical activity, while 20% of those age 75-84 and 11% of those 85 years and older participate. There are gender, racial, and geographic differences in participation in regular physical activity: men are more likely than women, Whites are more likely than Blacks or Hispanics, and those in the North-Central and Western States are more likely to engage in regular physical activity. The goal of Healthy People 2010 had been to increase the proportion of all adults who engage in regular physical activity to 30%.^{44, 73} In 2008, the US Department of Health and Human Services issued new physical activity guidelines for Americans in English and Spanish that describe the types and amounts of physical activity that offer substantial health benefits to Americans.⁷⁴ The new goals of Healthy People 2020 include reducing the proportion of adults who engage in no leisure-time physical activity and increasing the proportion of adults who meet current Federal physical activity guidelines for aerobic physical activity and for muscle-strengthening activity.⁷⁵

Recommendations

Older adults should consult their health care provider to determine what level of physical activity is safe and appropriate. Sedentary older adults should begin physical activity with short intervals of moderate activity (5 to 10 minutes).^{76, 77} Older adults should aim to do at least 150 minutes of moderate-intensity physical activity a week, or 75 minutes of vigorous-intensity activity a week. When older adults cannot meet these goals because of chronic conditions, they should be as physically active as their abilities allow. Aerobic activities such as jogging, walking, rolling a wheelchair, or swimming should be engaged in at least 3 days per week. Strength training involving multiple muscle groups, such as calisthenics, weight lifting, carrying laundry or groceries, chair exercises, or working in the yard, should be done at least 2 days per week.^{68, 74, 75}

Fall Risk Management

HEDIS Measure

The *Fall Risk Management* (FRM) measure consists of four questions to ascertain whether beneficiaries had a history of falls or problems with balance or walking, whether they discussed falls with a medical provider, and their provider's management of fall risk. Changes in 2017 include the addition of a hospice exclusion:

- Members with evidence from CMS administrative records of a hospice start date or hospice enrollment are excluded.

The following components of this measure assess different facets of fall risk management:

Discussing Fall Risk

The percentage of Medicare members 75 years of age and older, or 65–74 years of age with balance or walking problems or a fall in the past 12 months, who were seen by an MAO practitioner in the past 12 months, and who discussed falls or problems with balance or walking with their current practitioner.

Denominator Criteria for inclusion in the denominator depend on member age.

Members 65–74 years of age as of December 31 of the measurement year

Member response choices must be as follows to be included in the denominator:

Q48 = “Yes” or “No.”

Q49 = “Yes” or Q50 = “Yes.”

Members 75 years of age and older as of December 31 of the measurement year

Member response choices must be as follows to be included in the denominator:

Q48 = “Yes” or “No.”

Numerator Member response choices must be as follows to be included in the numerator:

Q48 = “Yes.”

Managing Fall Risk

The percentage of Medicare members 65 years of age and older who had a fall or had problems with balance or walking in the past 12 months, who were seen by an MAO practitioner in the past 12 months, and who received a recommendation for how to prevent falls or treat problems with balance or walking from their current practitioner.

Denominator Member response choices must be as follows to be included in the denominator:

Q48 = “Yes” or “No.”

Q49 = “Yes” or Q50 = “Yes.”

Q51 = “Yes” or “No.”

Numerator Member response choices must be as follows to be included in the numerator:

Q51 = “Yes.”

HOS Total Results

Table 38: Discussing Fall Risk Rate for STXXXX, CMS Region XX and HOS Total

	Mean	SD	P10	P25	Median	P75	P90	Min	Max
StateXX	34.87	1.10	33.75	33.79	34.94	35.69	36.18	33.75	36.18
CMS Region XX	34.59	0.96	33.44	33.79	34.64	35.11	35.94	33.13	36.18
HOS Total	36.50	7.13	29.36	31.29	34.63	39.48	47.47	24.20	61.16

Please see the note accompanying HEDIS Table 33 for the meaning of NC and NA.

Table 39: Managing Fall Risk Rate for STXXXX, CMS Region XX and HOS Total

	Mean	SD	P10	P25	Median	P75	P90	Min	Max
StateXX	58.12	1.53	56.35	56.58	58.88	59.29	59.49	56.35	59.49
CMS Region XX	57.50	1.35	56.06	56.44	57.14	58.88	59.39	55.77	59.49
HOS Total	58.62	8.94	49.12	52.31	56.91	63.60	71.54	41.46	89.74

Please see the note accompanying HEDIS Table 33 for the meaning of NC and NA.

Why Is It Important?

More than 30% of adults age 65 or older fall each year and falls are the most common cause of injuries and fatalities among the elderly.^{78, 79, 80, 81} Falls are also a common cause of nursing home admissions among older adults.⁸² Fall related injuries, such as hip fractures, are associated with significant functional decline, limited mobility, loss of ability to live independently, and decreased quality of life. In 2010 among adults age 65 and older, 21,759 fatal fall related injuries and 2.35 million non-fatal fall related injuries were treated in emergency rooms.⁸³ On average, the medical cost for a fall injury in an adult age 65 and older is \$18,010.⁸³ Fractures are the most common and most costly type of non-fatal injuries. Although only one third of non-fatal injuries are fractures, they account for 61% of the costs or \$12 billion.⁸⁴ The annual direct and indirect costs associated with falls are projected to reach \$54.9 billion (in 2007 dollars) by 2020.^{85, 86}

Risk Factors

The risk of fall related injuries increases with age. Adults 85 and older were four to five times more likely to have fall related injuries than adults 65-74 years of age.⁸⁷ Females are more likely than males to have non-fatal fall injuries, whereas males are more likely than females to have fatal fall injuries. Other risk factors for falls include: lack of physical activity, misuse of alcohol, taking of specific prescription drugs (e.g., psychotropic or narcotic medications), hearing or visual impairments, and unsafe home environments.^{87, 88}

Prevention

Regular exercise and exercise programs, e.g., tai chi, may increase strength and improve balance among older adults.⁷⁸ Regular medication reviews by physicians or pharmacists can help reduce side effects and drug interactions. Annual eye checkups are important for maintaining eye health. Home assessment and modifications may reduce hazards in the home, such as improper lighting, that can lead to falls.⁸⁵ Fall prevention programs may need to provide and install safety devices to effectively reduce environmental hazards.^{88, 89}

Osteoporosis Testing in Older Women

HEDIS Measure

The *Osteoporosis Testing in Older Women* (OTO) measure assesses the percentage of women age 65-85 who report ever having received a bone density test to check for osteoporosis. The age criteria for the measure were revised in 2015 to add an upper age limit. Changes in 2017 include the addition of a hospice exclusion:

- Members with evidence from CMS administrative records of a hospice start date or hospice enrollment are excluded.

Osteoporosis Testing in Older Women

This measure assesses the number of women 65-85 years of age who report ever having received a bone density test to check for osteoporosis.

Denominator Member response choices must be as follows to be included in the denominator:

Q52 = “Yes” or “No.”

Numerator Member response choices must be as follows to be included in the numerator:

Q52 = “Yes.”

HOS Total Results

Table 40: Osteoporosis Testing in Older Women Rate for STXXXX, CMS Region XX and HOS Total

	Mean	SD	P10	P25	Median	P75	P90	Min	Max
StateXX	76.33	2.32	72.80	75.20	77.38	77.85	78.42	72.80	78.42
CMS Region XX	76.62	1.87	73.69	75.20	77.27	77.85	78.52	72.80	78.62
HOS Total	74.24	10.47	59.38	66.07	76.17	82.14	86.31	45.56	93.10

Please see the note accompanying HEDIS Table 33 for the meaning of NC and NA.

Why Is It Important?

Osteoporosis is the most common bone disease. It is characterized by low bone mass and deterioration of bone strength, which leads to an increased risk of fractures.^{90, 91, 92} An estimated 10 million Americans age 50 and older have osteoporosis and 34 million have low bone mass. By 2020, half of all Americans age 50 and over could be at risk for osteoporosis.⁹³ Osteoporosis is a major cause of disability and mortality in older adults. Over 1.5 million fractures per year are attributable to osteoporosis. Each year, these fractures account for \$12-18 billion in direct health care costs, 500,000 hospitalizations, 800,000 emergency room visits, 2.6 million physician visits, and 180,000 nursing home admissions.⁹⁴ Prevention, diagnosis, and treatment of osteoporosis decreases injury and disability, improves quality of life for patients, and reduces costs to patients, caregivers, health care systems, and society.⁹⁵

Risk Factors

The risk of developing osteoporosis increases with age and is higher in females than males. Among females, risk is higher in the postmenopausal than in the pre-menopausal period. Risk is also higher in Whites and Asians than other race/ethnicity groups.⁹⁶ Other risk factors include: smoking, family history of osteoporosis, low weight and BMI, history of prior fracture, and taking certain medications that cause bone loss; e.g., oral glucocorticoids.^{92, 93, 94, 95, 96}

Prevention and Treatment

Adequate amounts of calcium and vitamin D, avoiding smoking and excessive alcohol, and regular weight bearing exercise all can help prevent osteoporosis.⁹⁷ Medications for prevention and treatment of osteoporosis include: bisphosphonates (e.g., alendronate and risedronate), calcitonin, estrogen replacement, and selective estrogen receptor antagonists.⁹⁸ Since 2007, zoledronic acid has been available as a once-yearly intravenous therapy.⁹⁰ Aerobics, weight bearing, resistance exercises, and walking are effective in increasing the bone mineral density (BMD) of the spine and the hip.⁹⁹

Appendix 1

Program Background

This section provides a brief introduction to the Medicare HOS. A complete description of the HOS program, the program timeline, the HOS 3.0 instrument, previous survey results, and supporting documents are available on the HOS website at www.HOSonline.org.

CMS is committed to monitoring the quality of care provided by MAOs. The HOS results continue to be an important part of the CMS quality improvement activities, to ensure that medical care paid for under the Medicare program meets professionally recognized standards of health care. Section 722 of the Medicare Prescription Drug, Improvement, and Modernization Act of 2003 (MMA) mandates collecting, analyzing, and reporting health outcomes information. This legislation also specifies that data collected on quality, outcomes, and beneficiary satisfaction to facilitate consumer choice and program administration must use the same types of data that were collected prior to November 1, 2003. Collected since 1998, the Medicare HOS is the first patient-reported outcomes measure in Medicare managed care, and therefore remains a critical part of assessing MAO quality. In addition, CMS includes the HOS results as one component of their performance assessment program.

The goal of the Medicare HOS program is to gather valid and reliable clinically meaningful data for uses such as: targeting quality improvement activities and resources; monitoring health plan performance; rewarding top-performing health plans; helping beneficiaries make informed health care choices; and advancing the science of functional health outcomes measurement. This HOS Baseline Report is part of a larger CMS effort to increase the health care industry's capacity to improve the health status of its Medicare population. The baseline results are intended to help MAOs identify areas for potential improvement. The report contains information on baseline measures of physical and mental health, chronic medical conditions, functional status (e.g., ADLs), clinical measures, NCQA HEDIS measures, and other health status indicators. The HOS Baseline Report is made available to all participating MAOs after each annual baseline cohort data collection is completed.

2017 Medicare Advantage Organization Participation

MAOs with Medicare contracts in effect on or before January 1, 2016, and a minimum enrollment of 500 beneficiaries were required to report the Baseline HOS in 2017:

- All coordinated care plans, including local and regional preferred provider organizations (PPO), health maintenance organizations (HMO), and contracts with Special Needs Plan (SNP) benefit packages
- Section 1876 cost contracts, even if closed for enrollment
- Private Fee-for-Service (PFFS) contracts
- Medical savings account (MSA) contracts
- Employer/union only contracts
- Medicare Medicaid Plans (MMP)

MAOs that administered the HOS Baseline Survey in 2015 were required to administer the HOS Follow-Up Survey in 2017.

All Program of All-Inclusive Care for the Elderly (PACE) organizations with Medicare contracts in effect on or before January 1, 2016, and with a minimum enrollment of 30 beneficiaries as of October 1, 2016, were required by CMS to administer the HOS-Modified (HOS-M) in 2017.

MAOs sponsoring Fully Integrated Dual Eligible (FIDE) SNPs within Medicare contracts in effect on or before January 1, 2016, and with a minimum enrollment of 50 beneficiaries could request a frailty adjustment assessment. The assessment determined eligibility for a frailty adjustment payment, similar to those payments provided to PACE programs that use HOS-M data. In 2017, plans were also permitted to choose whether their assessments would be calculated based on ADLs reported in the HOS or on a separate sample of beneficiaries who completed the HOS-M. Voluntary reporting for frailty assessment at the FIDE SNP level is in addition to standard HOS requirements for quality reporting at the contract level.

2017 Methodology and Design

Cohort 20 Baseline Sampling

- MAOs with fewer than 500 beneficiaries were not required to report HOS.
- For MAOs with 500 to 1,200 beneficiaries, all eligible beneficiaries were included in the sample.
- For MAOs with more than 1,200 beneficiaries and less than 3,000 beneficiaries, a simple random sample of 1,200 beneficiaries was selected for the baseline survey.
- For MAOs with 3,000 or more beneficiaries, beneficiaries who responded to the previous year's baseline survey were excluded from the random sample of 1,200 for the current year.
- Beneficiaries were defined as eligible if they were 18 years or older on the date the sample was drawn. The six months enrollment requirement was waived beginning in 2009, and beneficiaries with End Stage Renal Disease (ESRD) were no longer excluded from the sampling beginning in 2010.

Survey Administration

- MAOs contracted with a CMS approved survey vendor to administer the survey following the protocol specified in the HEDIS 2017, Volume 6, Specifications for the Medicare Health Outcomes Survey Manual. The manual detailed the methods for mail, telephone, and mixed methods of data collection.
- The mail component of the survey used prenotification letters, a standardized questionnaire, survey letters, and reminder/thank you postcards. Sample respondents completed the HOS in English, Spanish, or Chinese language versions of the mail survey.
- Survey vendors attempted telephone follow up in English or Spanish (with at least six attempts) in those instances when beneficiaries failed to respond after the second mail survey or returned an incomplete mail survey in order to obtain responses for missing items. A standardized version of an Electronic Telephone Interviewing System script was used to collect telephone interview data for the survey.
- Survey vendors performed initial data cleaning and follow up with survey respondents, as necessary.

Data Cleaning

The entire HOS data file was reviewed using SAS[®] 9.3 programs to verify the quality of the data submitted by survey vendors. Reliable and valid HOS data are essential for maintaining the integrity of HOS measures used in the Medicare Star Ratings. Data files were reviewed for errors prior to merging the files into a final HOS dataset. Vendor generated errors were identified for correction, while errors attributable to the survey respondent, such as skip pattern errors, were left 'as is' in the final HOS dataset.

- Data consistency checks were performed to identify:
 - Out of range dates and response values
 - Duplicate Beneficiary Link Keys, Health Insurance Claim (HIC) numbers and Social Security Numbers (SSN)
 - Data shifts in value assignment
 - Inconsistencies in data distributions of survey response values among vendors
 - Discrepancies in the percent complete and survey disposition codes
 - Inconsistent assignment of survey variables (such as survey disposition, round number, and survey language)
- Text files from vendors were concatenated into the final HOS dataset.
- Additional fields were created and added to the final HOS dataset such as the percent of survey completed, the number of ADL questions answered, indicators for ineligible and completed surveys, and the PCS and MCS Scores.

Medicare HOS 3.0 Instrument

The 2017 survey administration used the HOS 3.0 that was implemented in 2015. The HOS 3.0 evaluates the HRQOL of Medicare Advantage beneficiaries by measuring their physical and mental health status using the VR-12.¹⁰⁰ Modifications in the HOS 3.0 from the previous version (HOS 2.5) included: changes to questions about leakage of urine, osteoporosis testing in older women, sleep duration and quality, and primary language spoken in the home. In a formatting change, the survey uses a two column layout for each page.

The HOS also contains questions about: socio-demographics, ADLs, IADLs, chronic medical conditions, self-rated health, number of unhealthy days in the past 30 days, depression risk, cognitive functioning, memory, pain, living arrangements, and height and weight used for calculation of BMI. Four HEDIS Effectiveness of Care measures are included to evaluate management of urinary incontinence, physical activity, osteoporosis testing, and fall risk management. Questions regarding race, ethnicity, sex, primary language, and disability status are included to comply with standards established by Section 4302 of the Affordable Care Act. The 2017 HOS 3.0 and previous versions of HOS instruments are available on the Survey page of the HOS website (www.HOSonline.org).

The VR-12 was derived from the Veterans RAND 36-Item Health Survey (VR-36).^{101, 102, 103} The VR-12 is a generic, multipurpose health survey, which consists of the 12 most important items from the VR-36 for construction of the physical and mental health summary scores (questions Q1-Q7) and two items that assess change in physical and emotional health compared to one year ago (Q8 and Q9) that are not used in the calculation of the summary scores. The shorter instrument was adopted to reduce response burden and survey costs, while maintaining comparability of HOS results over time. The body of literature supports the shorter survey as a

reliable and valid substitute for the 36-item health survey. In addition, conversion formulas have been developed and validated for comparison of the VR-12 with the earlier 36-item survey that allows reliable comparisons of HOS results.¹⁰⁴

In comparison with the earlier 36-item survey, two modifications were made in the VR-12 and previously in the VR-36. The first modification was an increase in the number of response choices for the items used for role limitations due to physical problems (Q3a and Q3b) and role limitations due to emotional problems (Q4a and Q4b), from a two-point choice of “Yes” or “No” to a five-point Likert scale (“No, none of the time,” “Yes, a little of the time,” “Yes, some of the time,” “Yes, most of the time,” and “Yes, all of the time”). The role-physical questions assess whether respondents’ physical health limits them in the kind of work or other usual activities they perform, while the role-emotional questions assess whether emotional problems have caused respondents to accomplish less in their work or other usual activities. The second modification was that two questions were used to assess health change, one focusing on physical health (Q8) and one on emotional problems (Q9), in contrast to the one general change item in the 36-item survey.^{105, 106}

The VR-12 measures the same eight health domains as the 36-item health survey: 1) Physical Functioning, 2) Role-Physical, 3) Role-Emotional, 4) Bodily Pain, 5) Social Functioning, 6) Mental Health, 7) Vitality, and 8) General Health. Each domain aggregates one or two items and all eight domains are used to calculate the two summary measures, as illustrated in the VR-12 mapping model that follows in Figure 15.

Figure 15: Mapping of HOS VR-12 to 8 Health Domains and 2 Summary Measures

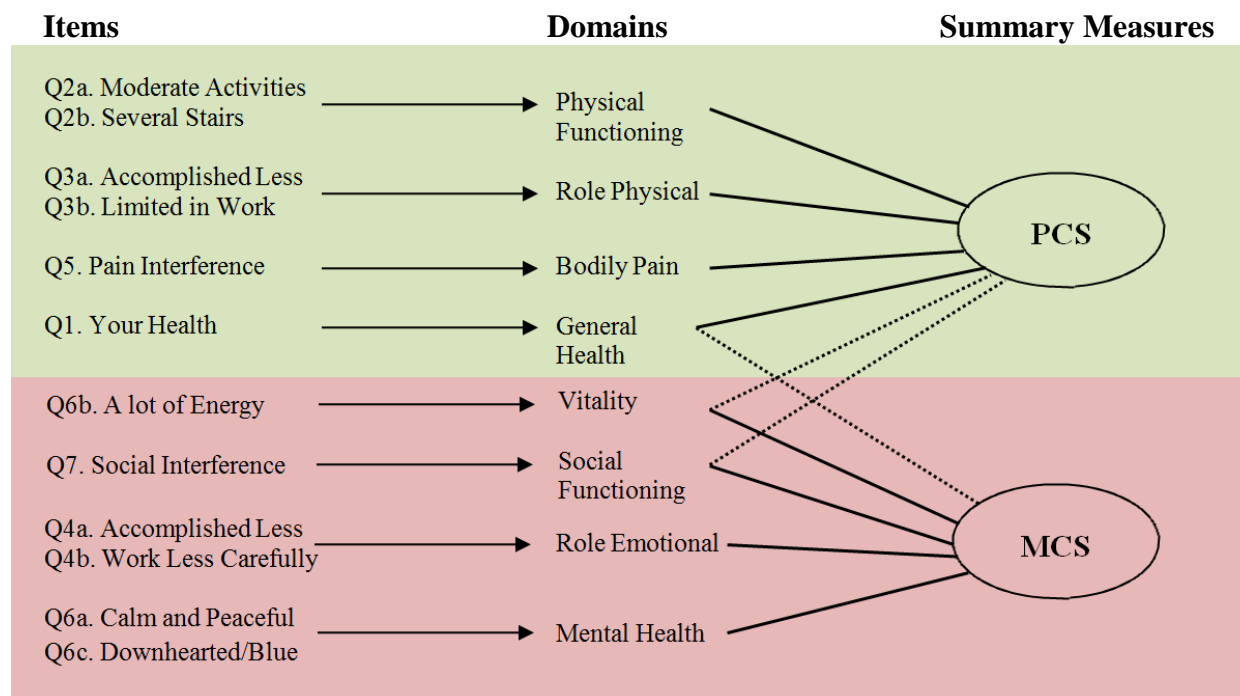

Note: Domains contributing the most to each summary measure are indicated by a solid line. Domains contributing to a lesser degree are indicated by a broken line; however, all domains contribute to some extent to the scoring of both summary measures (PCS and MCS).

Physical and Mental Component Summary Scores

- The PCS and MCS scores were calculated from the VR-12 using the Modified Regression Estimate (MRE) for scoring and imputation of missing data.¹⁰⁰ For those beneficiaries with complete responses across the VR-12, the following steps¹⁰⁷ were taken to calculate PCS and MCS:
 - Step One: New variables were created for each response level choice with one level omitted. Using the 59 total response categories across the VR-12 questions, 47 indicator variables were created.
 - Step Two: Aggregate PCS and MCS scores were created separately from a regression equation that weighted each of the 47 indicator variables. The weights were derived from the Veterans SF-36 PCS and MCS Scales using the 1999 Large Health Survey of Veteran Enrollees.¹⁰⁸
 - Step Three: A constant was added to each of the estimates obtained from Step Two. The scores were then standardized using normative values from a 1990 U.S. general population. Therefore, a mean score of 50 represents the national average, a 10-point difference above and below the mean score is one standard deviation, and, with few exceptions, the scores have a range of zero through 100 (higher being better).
- When a beneficiary had missing data across the VR-12 items, PCS and MCS scores were imputed using the MRE. Using the MRE algorithm, PCS and MCS scores can be calculated in as many as 90% of the cases in which one or more VR-12 responses are missing.¹⁰⁹ Depending on the pattern of missing item responses for a beneficiary, a different set of regression weights was required to compute that individual's PCS and/or MCS scores.¹⁰⁷ For each combination of missing data, the beneficiaries' data were merged with the stored regression weights and the PCS or MCS scores were computed and then standardized using the normative values from Step Three.
- Beneficiary PCS and MCS results were mode adjusted for the impact of telephone administration compared to the reference mode of mail administration. Comparisons across the VR-12 of matched HOS and Veterans Administration surveys for the same respondents showed that PCS and MCS scores were, on average, 1.9 and 4.5 points greater respectively for telephone compared to mail administered surveys.¹¹⁰ Therefore, for telephone surveys, 1.9 points were subtracted from the PCS score and 4.5 points were subtracted from the MCS score.
- For the physical health summary measure, very high scores indicate no physical limitations, disabilities, or decline in well-being; high energy level; and a rating of health as "excellent."
- For the mental health summary measure, very high scores indicate frequent positive affect, absence of psychological distress, and no limitations in usual social and role activities due to emotional problems.

Case-Mix Adjustment for Comparison of MAOs at Baseline

- Beneficiaries are not randomly assigned to MAOs. Therefore, unadjusted PCS and MCS scores may be biased by demographic and chronic health characteristics that are disproportionately represented in some MAOs. For this reason, the PCS and MCS scores were case-mix adjusted to allow for equitable comparisons across all MAOs. In the context of the HOS, case-mix refers to those beneficiary characteristics measured at

baseline (such as age and the presence of chronic conditions) that are outside the control and influence of the MAO, but that may contribute to better or worse physical and/or mental health summary scores.¹⁰⁹ Case-mix adjustment is a statistical technique that uses multiple regression models to control for those differences, thus allowing comparisons in performance and quality across MAOs.

- Models used to adjust the summary scores included variables to control for differences in demographic and socioeconomic characteristics, chronic medical conditions, and HOS study design variables.
 - Demographic and socioeconomic characteristics included age, gender, race, education, marital status, and annual household income.
 - Chronic medical conditions were measured from 15 questions about medical conditions.
 - HOS study design variables included who completed the survey, CMS Region, and the survey vendor.
- Three different generalized linear regression models were used to adjust PCS and MCS scores since not all beneficiaries responded to all survey questions. Only one model, the most comprehensive model possible, was used to calculate an adjusted score for each beneficiary.
 - Model One: If a beneficiary had completed data for all of the covariates, then the adjusted scores were calculated using Model One, which contains all variables.
 - Model Two: If the beneficiary had completed data for all covariates except annual household income, which traditionally has the highest rate of missing data, then Model Two was used.
 - Model Three: If a beneficiary did not have enough completed data for Model One or Two, then Model Three was used. Age, gender, race, CMS Region, and survey vendor were included in Model Three because they were available for all sampled beneficiaries.
- Adjusted MAO scores can only be calculated with use of the complete HOS dataset.

Table 41: Covariates Used in the Case Mix Adjustment of PCS and MCS Scores

DEMOGRAPHICS COVARIATES	MODELS		
	ONE	TWO	THREE
Age (Integer)	√	√	√
Gender (Male or Female)	√	√	√
CMS Race (Black, Other Minority)	√	√	√
Education	√	√	
Marital Status	√	√	
Annual Household Income	√		
CHRONIC MEDICAL CONDITIONS			
Hypertension or high blood pressure	√	√	
Angina pectoris or coronary artery disease	√	√	
Congestive heart failure	√	√	
Myocardial infarction or heart attack	√	√	
Other heart conditions, such as problems with heart valves or arrhythmias	√	√	
Stroke	√	√	
Emphysema, or asthma, or COPD (Chronic Obstructive Pulmonary Disease)	√	√	
Crohn's disease, ulcerative colitis, or inflammatory bowel disease	√	√	
Arthritis of the hip or knee	√	√	
Arthritis of the hand or wrist	√	√	
Osteoporosis	√	√	
Sciatica	√	√	
Diabetes, high blood sugar, or sugar in the urine	√	√	
Depression	√	√	
Any cancer (other than skin cancer)	√	√	
HOS STUDY DESIGN VARIABLES			
Who Completed Survey (Self or Other)	√	√	
CMS Region	√	√	√
Survey Vendor	√	√	√

Note: Model One included all covariates listed in Table 41 and was used for beneficiaries with completed data for all of the covariates. Model Two was used for beneficiaries with completed data for all of the covariates except annual household income. Model Three was limited to age, gender, race, CMS Region, and survey vendor, and was used for beneficiaries who did not have enough completed data for Model One or Model Two. The variables included in Model Three were available for all participating beneficiaries.

Appendix 2

2017 Cohort 20 Baseline Frequencies of Survey Fields for MAO HXXXXA

The frequency graphs on the following pages are available for the majority of questions for your MAO's 2017 Cohort 20 Baseline analytic sample, with the exception of the demographic information in Q55 through Q68, which is provided in the Demographics and BMI tables in the Baseline Results section.⁴ Please note that the percentages in the graphs may not add to 100% due to rounding.

Note that the response frequencies in graphs for questions used in the four HEDIS Effectiveness of Care measures (Q42-Q52) are displayed for the 2017 Cohort 20 Baseline analytic sample only, and not the combination of the complete round of data (2017 Cohort 20 Baseline and 2017 Cohort 18 Follow Up data), as reported in the NCQA HEDIS Measures section.

Q1. In general, would you say your health is:

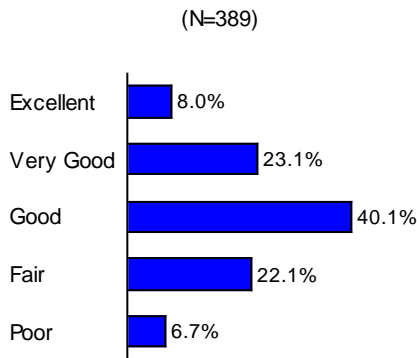

Q2a. Does your health now limit you in moderate activities, such as moving a table, pushing a vacuum cleaner, bowling, or playing golf?

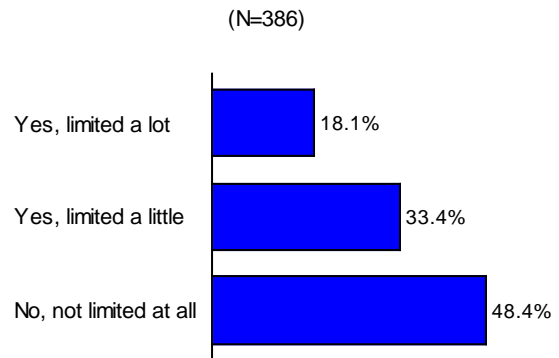

Q2b. Does your health now limit you in climbing several flights of stairs?

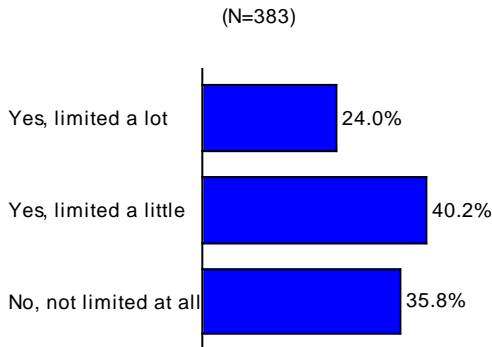

Q3a. During the past 4 weeks, have you accomplished less than you would like with your work or other regular daily activities as a result of your physical health?

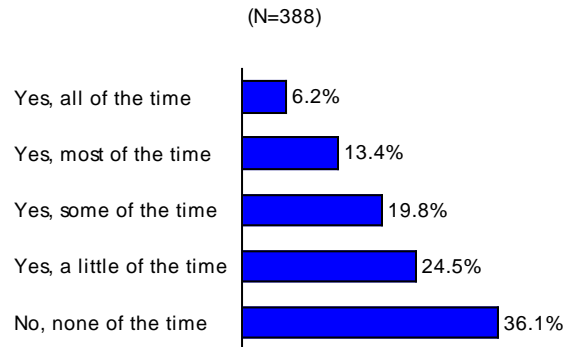

⁴ The actual phrasing for the 2017 Medicare HOS 3.0 survey questions is available on the HOS website at http://hosonline.org/globalassets/hos-online/survey-instruments/hos_2017_survey_English.pdf.

Q3b. During the past 4 weeks, were you limited in the kind of work or other activities as a result of your physical health?

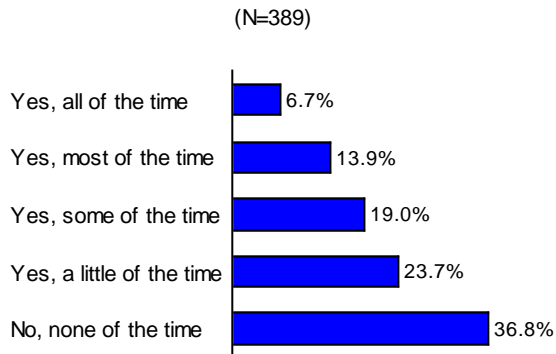

Q4a. During the past 4 weeks, have you accomplished less than you would like with your work or other regular daily activities as a result of any emotional problems?

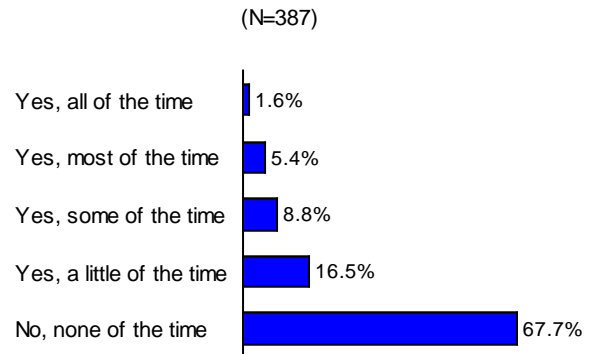

Q4b. During the past 4 weeks, did you not do work or other activities as carefully as usual as a result of any emotional problems?

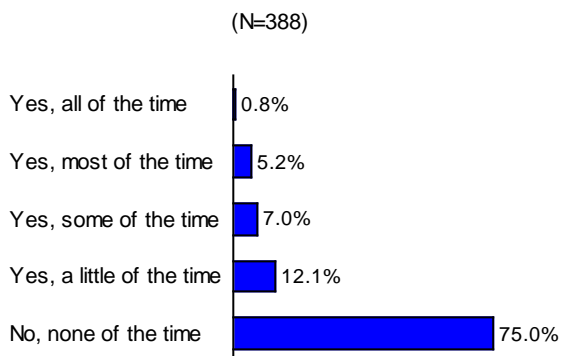

Q5. During the past 4 weeks, how much did pain interfere with your normal work (including both work outside the home and housework)?

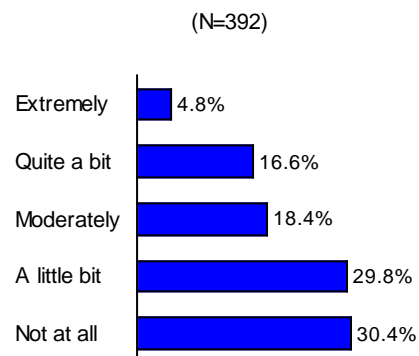

Q6a. How much of the time during the past 4 weeks: Have you felt calm and peaceful?

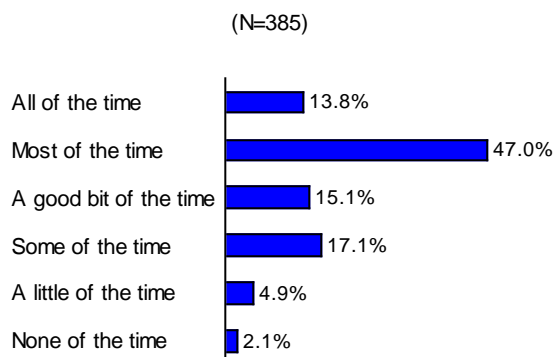

Q6b. How much of the time during the past 4 weeks: Did you have a lot of energy?

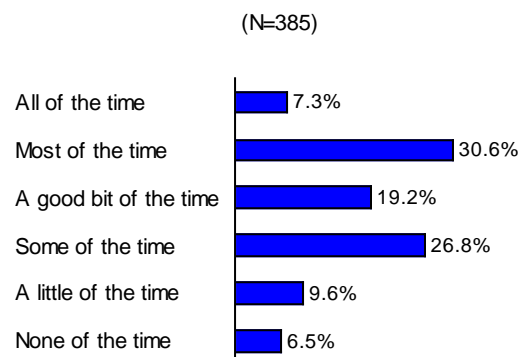

Q6c. How much of the time during the past 4 weeks: Have you felt downhearted and blue?

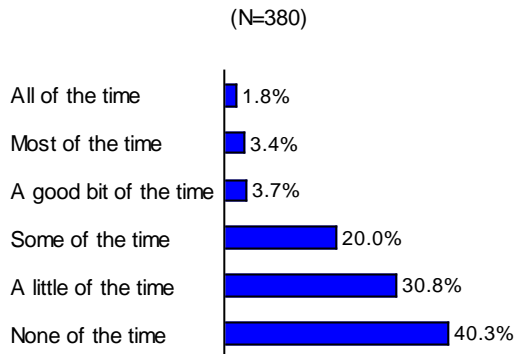

Q7. During the past 4 weeks, how much of the time has your physical health or emotional problems interfered with your social activities (like visiting with friends, relatives, etc.)?

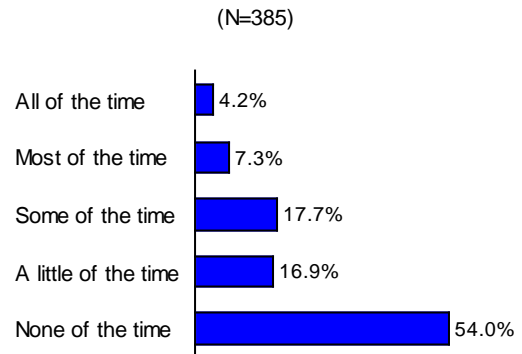

Q8. Compared to one year ago, how would you rate your physical health in general now?

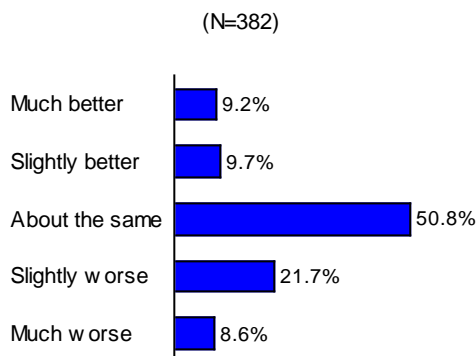

Q9. Compared to one year ago, how would you rate your emotional problems (such as feeling anxious, depressed or irritable) in general now?

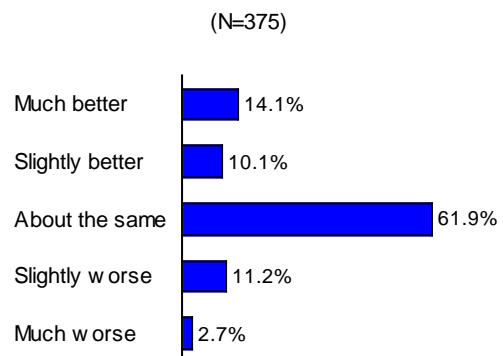

Q10a. Because of a health or physical problem, do you have any difficulty doing the following activities without special equipment or help from another person: Bathing?

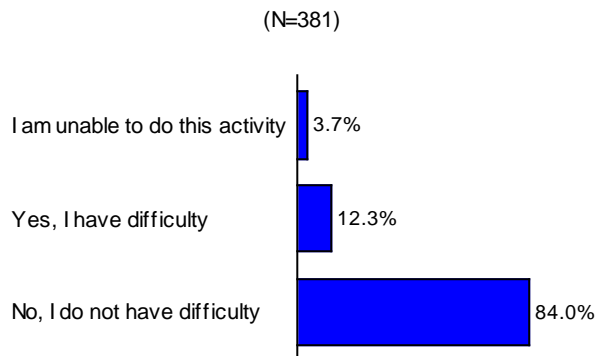

Q10b. Because of a health or physical problem, do you have any difficulty doing the following activities without special equipment or help from another person: Dressing?

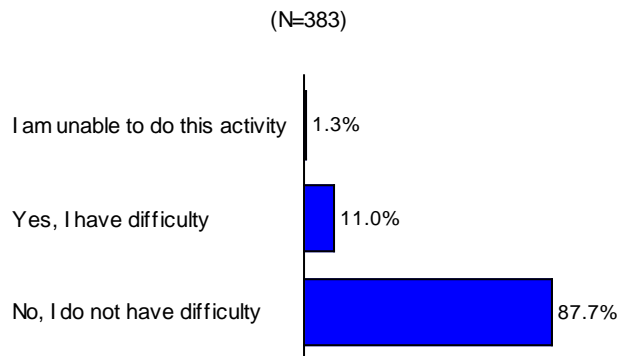

Q10c. Because of a health or physical problem, do you have any difficulty doing the following activities without special equipment or help from another person: Eating?

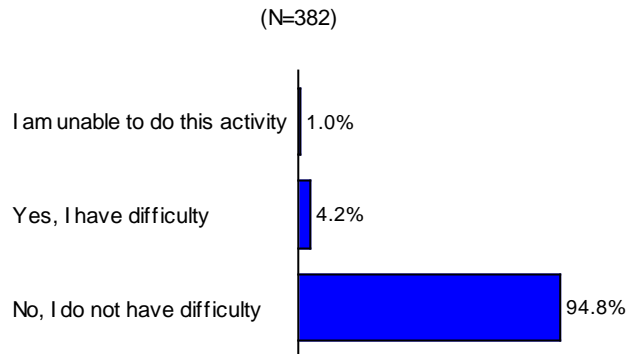

Q10d. Because of a health or physical problem, do you have any difficulty doing the following activities without special equipment or help from another person: Getting in or out of chairs?

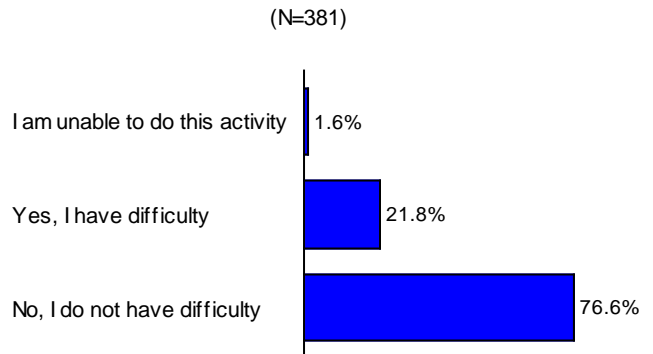

Q10e. Because of a health or physical problem, do you have any difficulty doing the following activities without special equipment or help from another person: Walking?

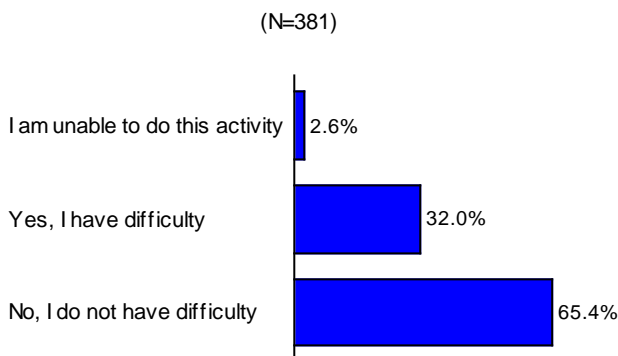

Q10f. Because of a health or physical problem, do you have any difficulty doing the following activities without special equipment or help from another person: Using the toilet?

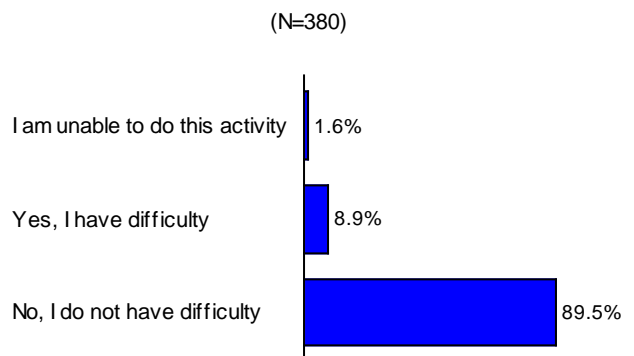

Q11a. Because of a health or physical problem, do you have any difficulty preparing meals?

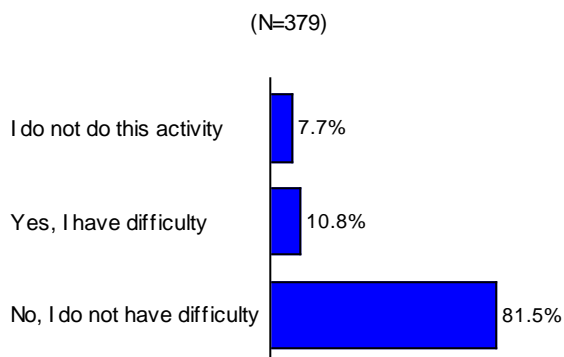

Q11b. Because of a health or physical problem, do you have any difficulty managing money?

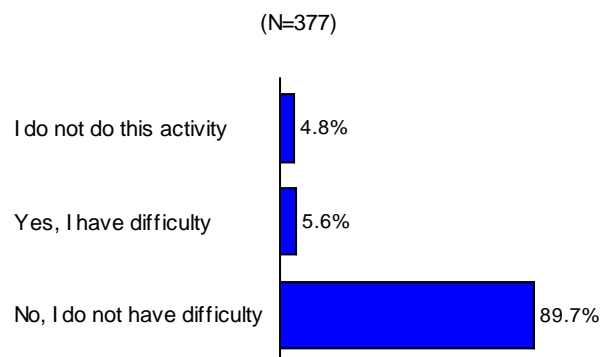

Q11c. Because of a health or physical problem, do you have any difficulty taking medication as prescribed?

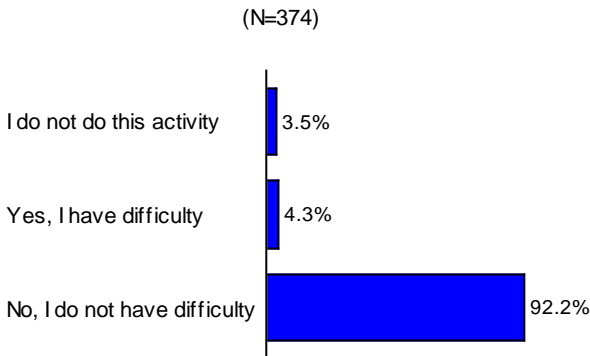

Q12. Now thinking about your physical health, which includes physical illness and injury, for how many days during the past 30 days was your physical health not good?

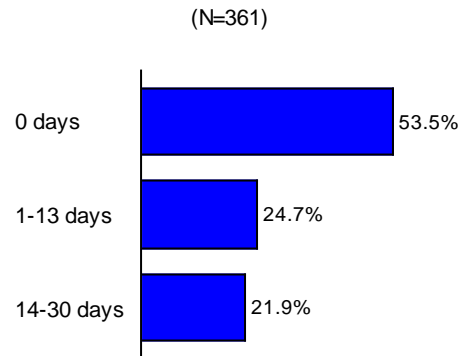

Q13. Now thinking about your mental health, which includes stress, depression, and problems with emotions, for how many days during the past 30 days was your mental health not good?

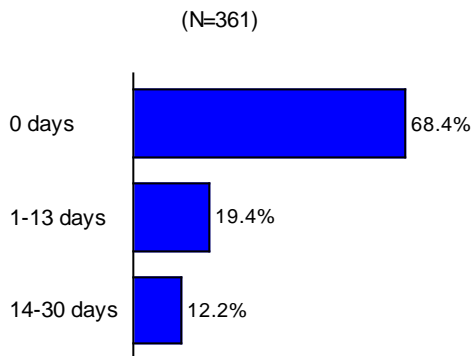

Q14. During the past 30 days, for about how many days did poor physical or mental health keep you from doing your usual activities, such as self-care, work, or recreation?

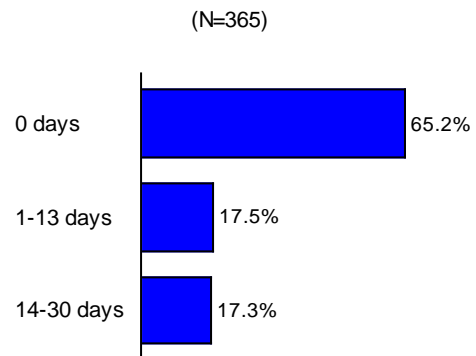

Q15. Are you blind or do you have serious difficulty seeing, even when wearing glasses?

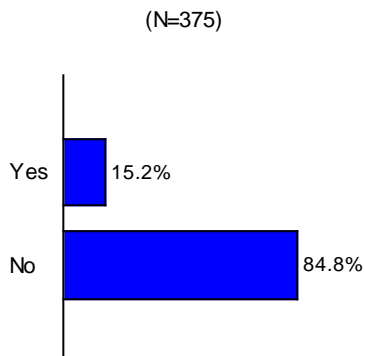

Q16. Are you deaf or do you have serious difficulty hearing, even with a hearing aid?

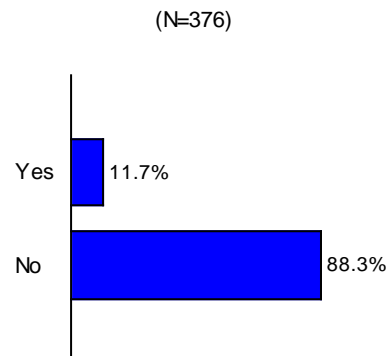

Q17. Because of a physical, mental, or emotional condition, do you have serious difficulty concentrating, remembering or making decisions?

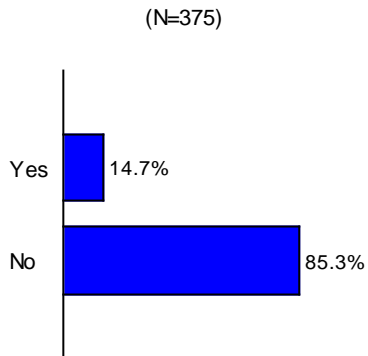

Q18. Because of a physical, mental, or emotional condition, do you have difficulty doing errands alone such as visiting a doctor's office or shopping?

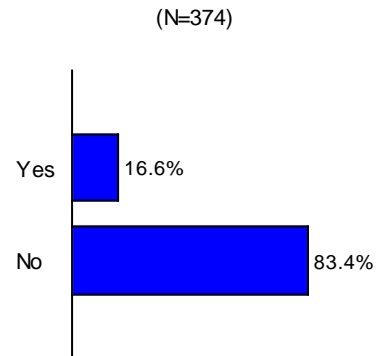

Q19. In the past month, how often did memory problems interfere with your daily activities?

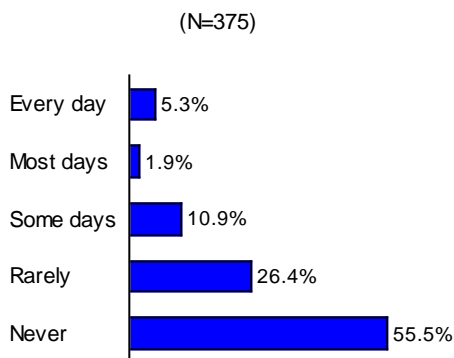

Q20. Has a doctor ever told you that you had: Hypertension or high blood pressure?

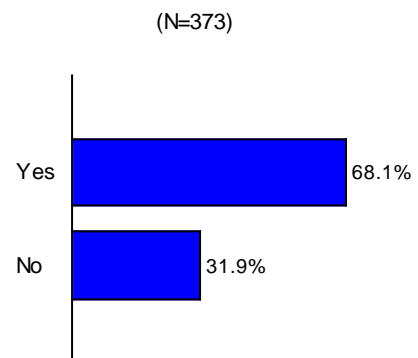

Q21. Has a doctor ever told you that you had: Angina pectoris or coronary artery disease?

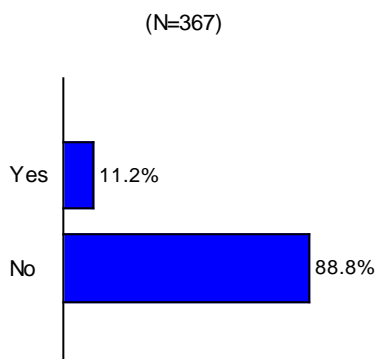

Q22. Has a doctor ever told you that you had: Congestive heart failure?

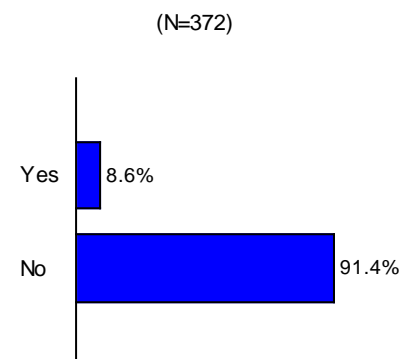

Q23. Has a doctor ever told you that you had:
A myocardial infarction or heart attack?

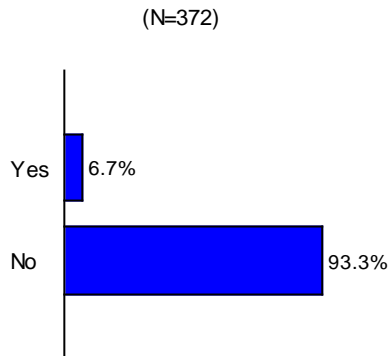

Q24. Has a doctor ever told you that you had:
Other heart conditions, such as problems with heart
valves or the rhythm of your heartbeat?

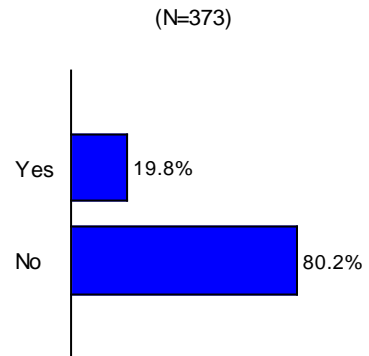

Q25. Has a doctor ever told you that you had:
A stroke?

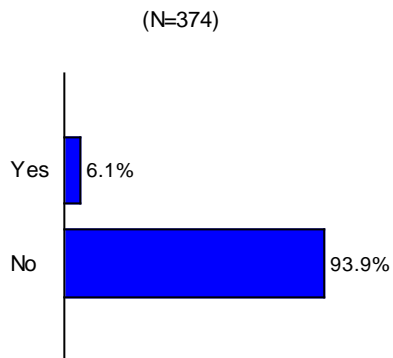

Q26. Has a doctor ever told you that you had:
Emphysema, or asthma, or COPD (chronic obstructive
pulmonary disease)?

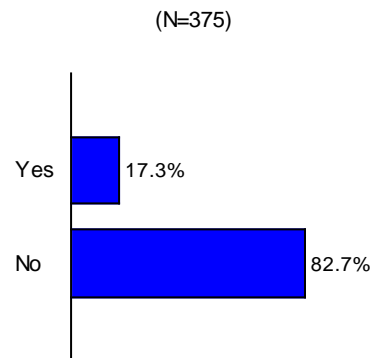

Q27. Has a doctor ever told you that you had:
Crohn's disease, ulcerative colitis, or inflammatory
bowel disease?

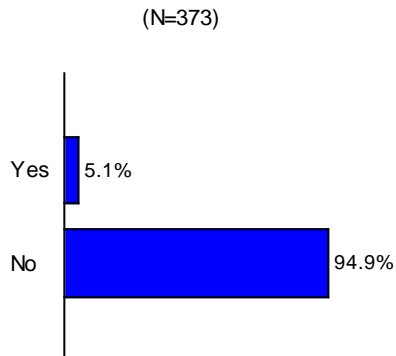

Q28. Has a doctor ever told you that you had:
Arthritis of the hip or knee?

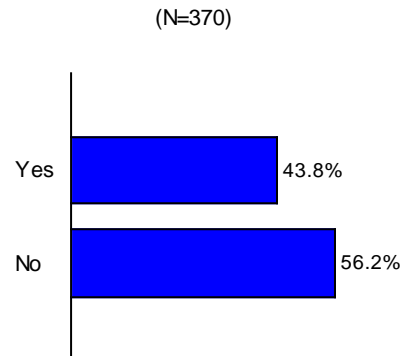

Q29. Has a doctor ever told you that you had:
Arthritis of the hand or wrist?

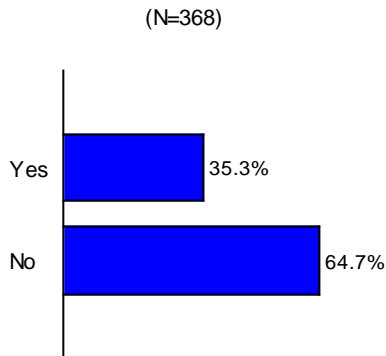

Q30. Has a doctor ever told you that you had:
Osteoporosis, sometimes called thin or brittle bones?

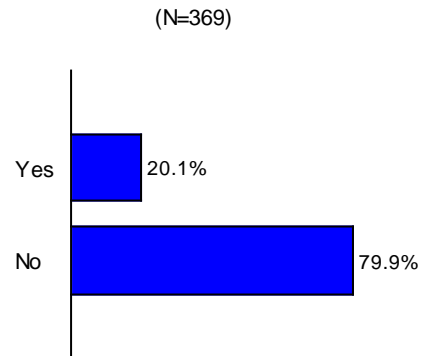

Q31. Has a doctor ever told you that you had:
Sciatica (pain or numbness that travels down your leg
to below your knee)?

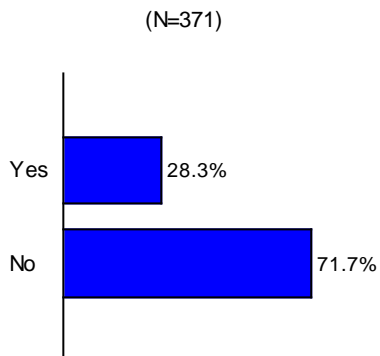

Q32. Has a doctor ever told you that you had:
Diabetes, high blood sugar, or sugar in the urine?

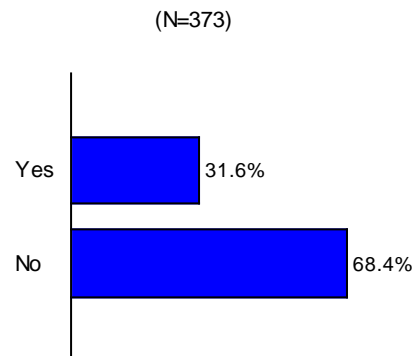

Q33. Has a doctor ever told you that you had:
Depression?

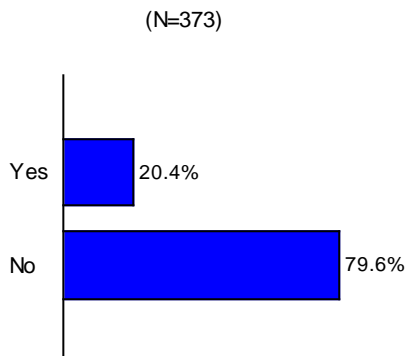

Q34. Has a doctor ever told you that you had:
Any cancer (other than skin cancer)?

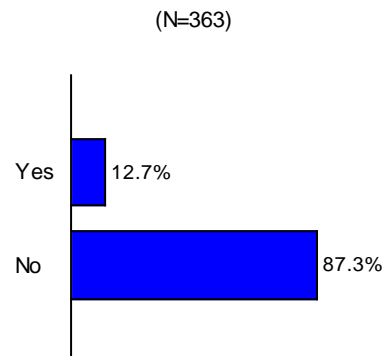

Q35a. Are you currently under treatment for:
Colon or rectal cancer?

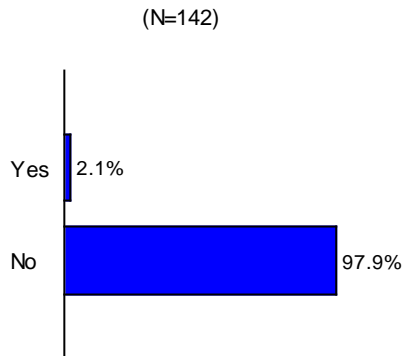

Q35b. Are you currently under treatment for:
Lung cancer?

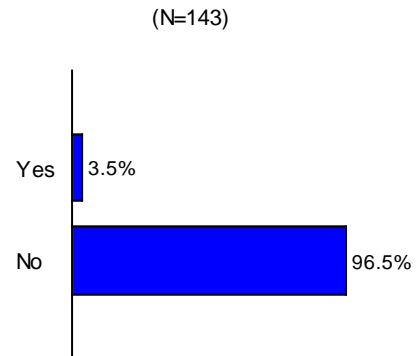

Q35c. Are you currently under treatment for:
Breast cancer?

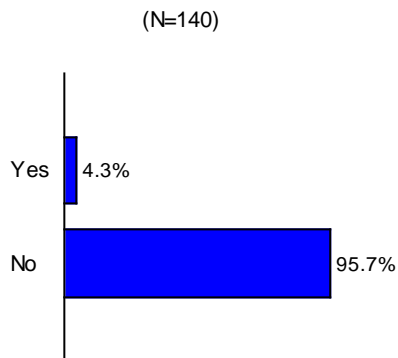

Q35d. Are you currently under treatment for:
Prostate cancer?

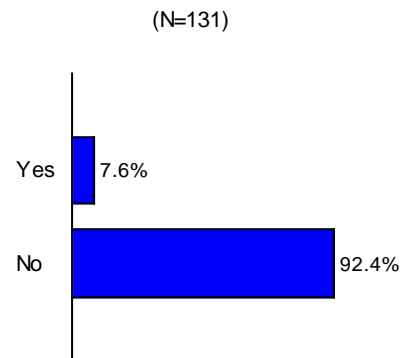

Q35e. Are you currently under treatment for: Other
cancer (other than skin cancer)?

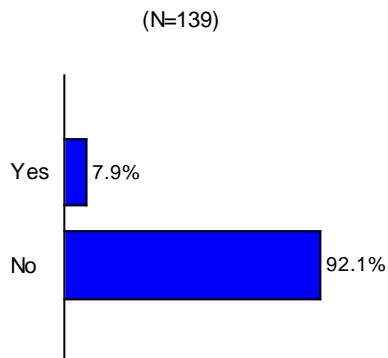

Q36. In the past 7 days, how much did pain interfere
with your day to day activities?

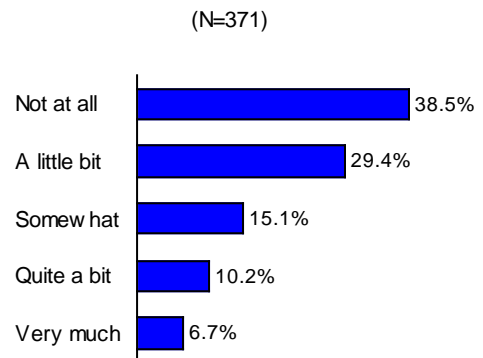

Q37. In the past 7 days, how often did pain keep you from socializing with others?

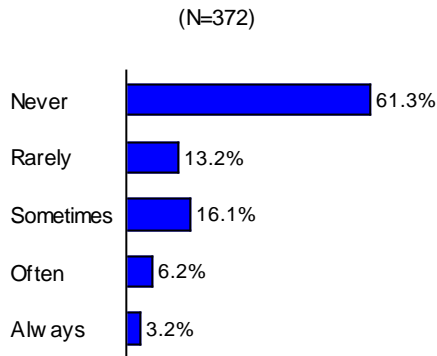

Q38. In the past 7 days, how would you rate your pain on average?

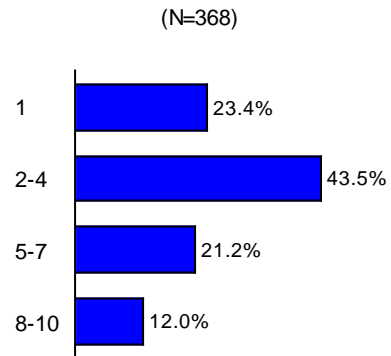

Q39a. Over the past 2 weeks, how often have you had little interest or pleasure in doing things?

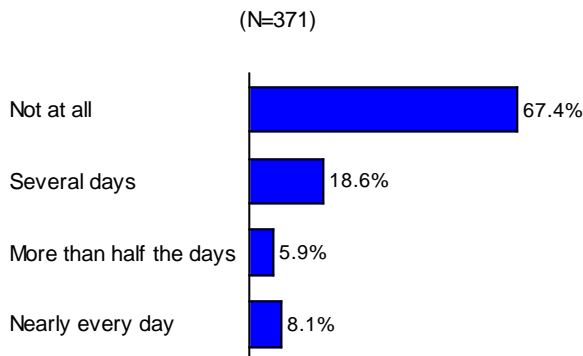

Q39b. Over the past 2 weeks, how often have you felt down, depressed or hopeless?

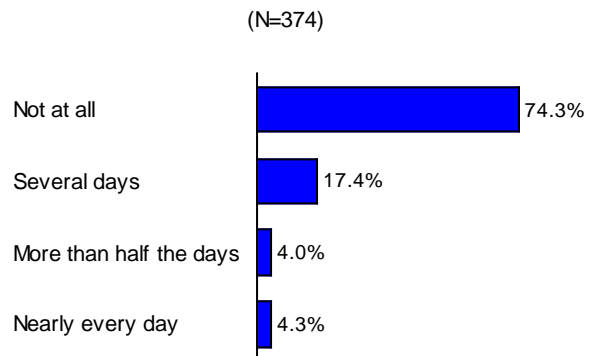

Q40. In general, compared to other people your age, would you say that your health is:

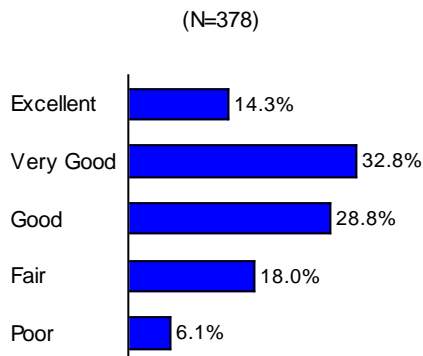

Q41. Do you now smoke every day, some days, or not at all?

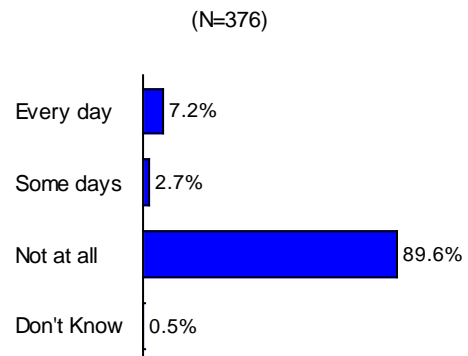

Q42. Many people experience leakage of urine, also called urinary incontinence. In the past six months, have you experienced leaking of urine?

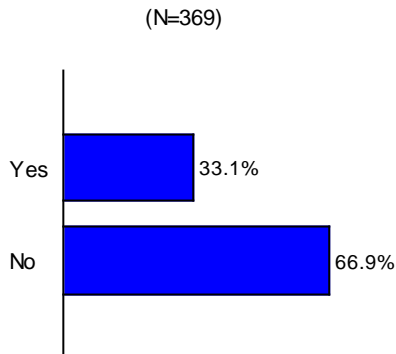

Q43. During the past six months, how much did leaking of urine make you change your daily activities or interfere with your sleep?

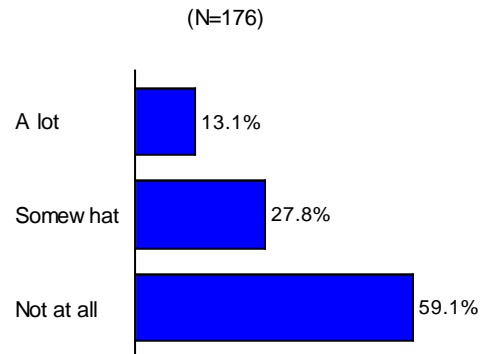

Q44. Have you ever talked with a doctor, nurse or other health care provider about leaking of urine?

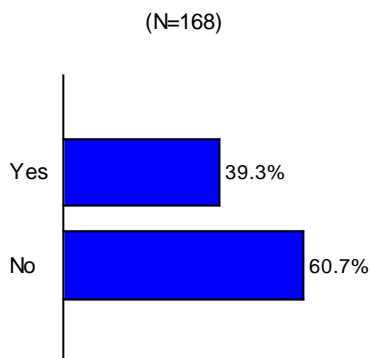

Q45. Have you ever talked with a doctor, nurse, or other health care provider about any of these approaches? (bladder training, exercises, medication, surgery)

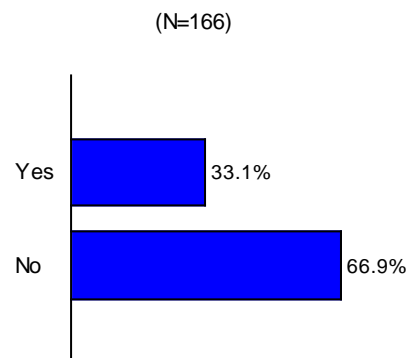

Q46. In the past 12 months, did you talk with a doctor or other health provider about your level of exercise or physical activity?

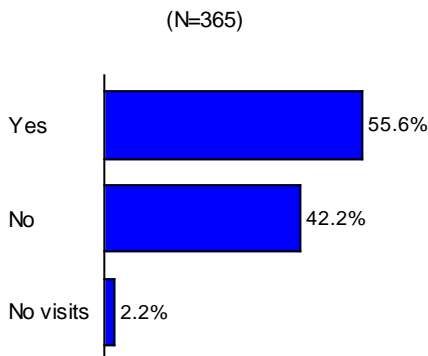

Q47. In the past 12 months, did a doctor or other health provider advise you to start, increase or maintain your level of exercise or physical activity?

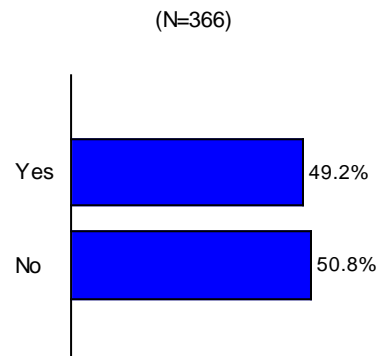

Q48. A fall is when your body goes to the ground without being pushed. In the past 12 months, did you talk with your doctor or other health provider about falling or problems with balance or walking?

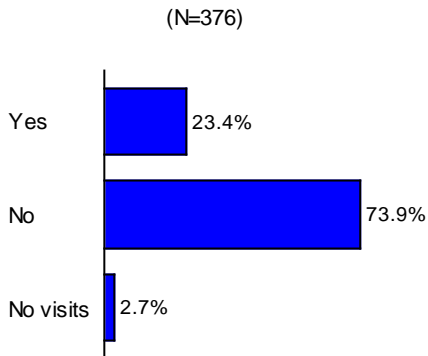

Q49. Did you fall in the past 12 months?

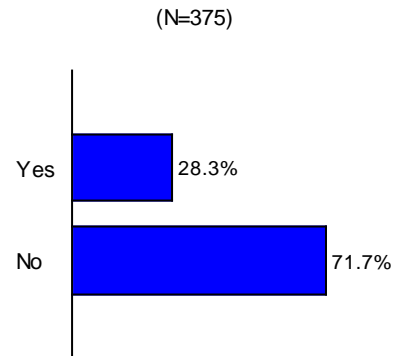

Q50. In the past 12 months, have you had a problem with balance or walking?

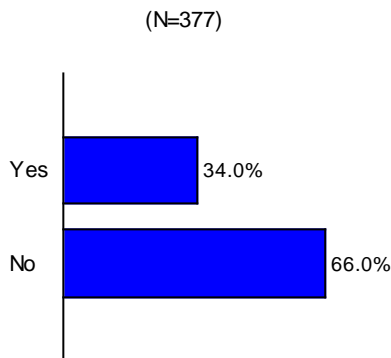

Q51. Has your doctor or other health provider done anything to help prevent falls or treat problems with balance or walking?

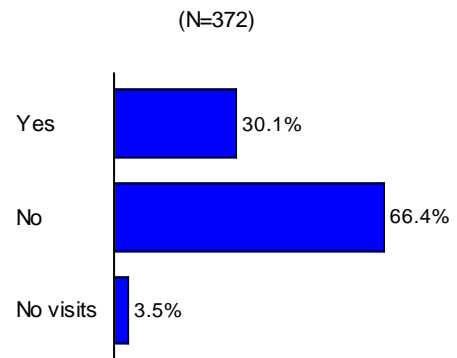

Q52. Have you ever had a bone density test to check for osteoporosis, sometimes thought of as 'brittle bones'?

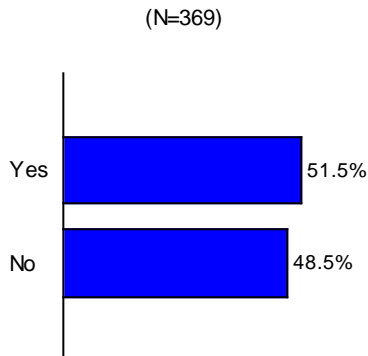

Q53. During the past month, on average, how many hours of actual sleep did you get at night?

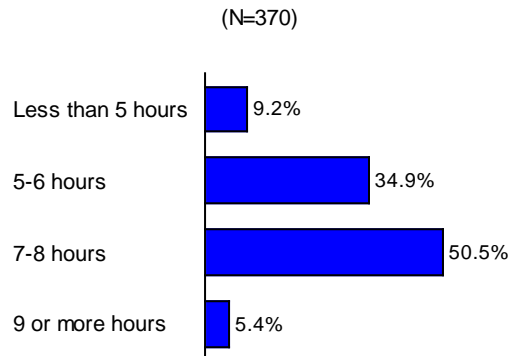

Q54. During the past month, how would you rate your overall sleep quality?

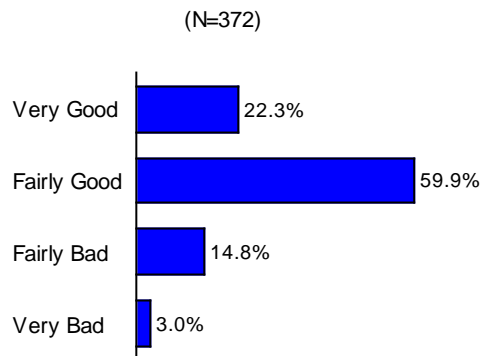

Appendix 3

Table 42: 2017 Cohort 20 Baseline Mean Unadjusted and Adjusted PCS and MCS Scores for All MAOs in STXXXX and HOS Total

	Unadjusted PCS Score (SD)	Adjusted PCS Score (SD)	Unadjusted MCS Score (SD)	Adjusted MCS Score (SD)
HXXXXA	39.2 (12.2)	39.2 (6.9)	53.0 (10.8)	52.8 (5.5)
HXXXXB	38.8 (12.6)	39.3 (7.0)	53.3 (10.7)	53.2 (5.5)
HXXXXC	39.2 (12.4)	38.9 (7.0)	52.9 (10.7)	53.2 (5.8)
HXXXXD	39.0 (12.6)	39.1 (7.3)	53.0 (10.9)	53.1 (5.5)
HXXXXE	38.8 (12.5)	39.1 (7.1)	52.9 (11.2)	52.7 (6.2)
StateXX	39.0 (12.5)	39.1 (7.1)	53.0 (10.9)	53.0 (5.7)
HOS Total	39.1 (12.6)	39.1 (7.1)	52.8 (11.0)	52.8 (5.7)

Table 43: 2017 NCQA HEDIS Rates for All MAOs in STXXXX, CMS Region XX, and HOS Total

	MUI Discuss Rate	MUI Treat Rate	MUI Impact Rate	PAO Discuss Rate	PAO Advise Rate	FRM Discuss Rate	FRM Manage Rate	OTO Testing Rate
HXXXXA	58.59%	45.45%	13.86%	58.67%	51.38%	33.79%	56.58%	78.42%
HXXXXB	59.47%	44.97%	15.63%	55.83%	50.94%	34.94%	59.29%	77.85%
HXXXXC	58.11%	44.14%	13.78%	56.79%	50.74%	33.75%	56.35%	77.38%
HXXXXD	60.00%	45.56%	15.52%	57.89%	51.96%	36.18%	58.88%	75.20%
HXXXXE	59.74%	44.81%	15.82%	53.67%	49.33%	35.69%	59.49%	72.80%
StateXX	59.18%	44.99%	14.92%	56.57%	50.87%	34.87%	58.12%	76.33%
CMS Region XX	58.68%	44.84%	14.79%	57.08%	51.45%	34.59%	57.50%	76.62%
HOS Total	59.33%	45.44%	15.88%	55.70%	51.74%	36.50%	58.62%	74.24%

References

- ¹ HEDIS[®] is a registered trademark of the National Committee for Quality Assurance.
- ² U.S. Department of Health and Human Services. Healthy People 2020. Available at: www.healthypeople.gov/2020/about/CoLWBabout.aspx. Accessed on: Feb 16, 2018.
- ³ Idler EL and Benyamini Y. Self-rated health and mortality: a review of twenty-seven community studies. *Journal of Health and Social Behavior*. 1997; 38(1):21-37.
- ⁴ The Centers for Disease Control and Prevention. Health-Related Quality of Life (HRQOL). Available at: www.cdc.gov/hrqol/faqs.htm. Accessed on: Feb 16, 2018.
- ⁵ U.S. Department of Health and Human Services. Healthy People 2020. Available at: www.healthypeople.gov. Accessed on: Feb 16, 2018.
- ⁶ Miller SL, Wolfe RR. The danger of weight loss in the elderly. *Journal of Nutrition, Health and Aging*. 2008; 12(7):487-491.
- ⁷ Health Services Advisory Group. *Medicare Health Outcomes Survey: Prevalence of Obesity in Medicare Advantage Organizations and Its Effect on Health Services Utilization and Health-Related Quality of Life*. 2011. Available at: http://www.hosonline.org/globalassets/hos-online/publications/prevalence_of_obesity_in_maos_final_technical_report_2011.pdf. Accessed on: Feb 16, 2018.
- ⁸ The Centers for Disease Control and Prevention. Overweight and Obesity. Available at: <http://www.cdc.gov/obesity>. Accessed on: Feb 16, 2018.
- ⁹ National Committee for Quality Assurance. *HEDIS[®] 2017, Volume 6: Specifications for the Medicare Health Outcomes Survey*. Washington, DC: NCQA Publication, 2017. Available at: http://www.hosonline.org/globalassets/hos-online/publications/hos_hedis_volume6_2017.pdf. Accessed on: Feb 16, 2018.
- ¹⁰ Health Services Advisory Group. *Analysis of Key Drivers of Improving or Maintaining Medicare Health Outcomes Survey (HOS) Scores*. 2013. Available at: http://www.hosonline.org/globalassets/hos-online/publications/key_drivers_medicare_hos_scores_2013.pdf. Accessed on: Feb 16, 2018.
- ¹¹ National Committee for Quality Assurance. *Opportunities for Improving Medicare HOS Results Through Practices in Quality Preventive Health Care for the Elderly: A Guide for Medicare Advantage Organizations*. 2012. Available at: http://hosonline.org/globalassets/hos-online/publications/opportunities_for_improving_medicare_hos_results_2012.pdf. Accessed on: Feb 16, 2018.
- ¹² Center for the Assessment of Pharmaceutical Practices (CAPP), Department of Health Policy and Management, Boston University School of Public Health. *Functional Status in Older Adults: Intervention Strategies for Impacting Patient Outcomes*. 2011. Available at: http://hosonline.org/globalassets/hos-online/publications/functional_status_in_older_adults_2011.pdf. Accessed on: Feb 16, 2018.
- ¹³ U.S. Department of Health and Human Services. Healthy People 2020. Available at: <https://www.healthypeople.gov/2020/about/foundation-health-measures/General-Health-Status>. Accessed on: Feb 16, 2018.
- ¹⁴ Ware JE, Kosinski M, and Keller SD. *SF-36 Physical and Mental Health Summary Scales: A User's Manual*. Boston, MA: The Health Institute; 1994.
- ¹⁵ Bailis DS, Segall A, and Chipperfield JG. Two views of self-rated general health status. *Social Science & Medicine*. 2003; 56:203-217.
- ¹⁶ Health Services Advisory Group. *Medicare Health Outcomes Survey: The Evaluation of a Mental Component Summary Score Threshold for Depression Risk in the Medicare Population*. 2006.

-
- Available at: http://hosonline.org/globalassets/hos-online/publications/hos_evaluation_mcs_depress.pdf. Accessed on: Feb 16, 2018.
- ¹⁷ Choi NG, DiNitto DM, et al. Suicide Means among Decedents Aged 50+ Years, 2005–2014: Trends and Associations with Sociodemographic and Precipitating Factors. *American Journal of Geriatric Psychiatry*. December 2017; 25(12):1404–1414. Available at: [http://www.ajgponline.org/article/S1064-7481\(17\)30345-7/abstract](http://www.ajgponline.org/article/S1064-7481(17)30345-7/abstract). Accessed on Mar 5, 2018.
- ¹⁸ Centers for Disease Control and Prevention. *The State of Aging and Health in America 2013*. Available at: <https://www.cdc.gov/aging/pdf/state-aging-health-in-america-2013.pdf>. Accessed on: Feb 16, 2018.
- ¹⁹ Anderson RJ, Freedland KE, Clouse RE, Lustman PJ. The prevalence of comorbid depression in adults with diabetes: a meta-analysis. *Diabetes Care*. 2001; 24:1069-1078.
- ²⁰ Hitchcock PH, Williams JW, Unutzer J, Worchel J, Lee S, Cornell J, Katon W, Harpole LH, Hunkeler E. Depression and comorbid illness in elderly primary care patients: impact on multiple domains of health status and well-being. *Annals of Family Medicine*. 2004; 2(6):555-562.
- ²¹ Li C, Friedman B, Conwell Y, Fiscella K. Validity of the Patient Health Questionnaire 2 (PHQ-2) in Identifying Major Depression in Older People. *Journal of American Geriatrics Society*. 2007; 55:596-602.
- ²² Kroenke K, Spitzer RL, Williams JBW. The Patient Health Questionnaire-2: Validity of a Two-Item Depression Screener. *Medical Care*. 2003; 41(11): pp 1284–1292.
- ²³ Substance Abuse and Mental Health Administration. The DAWN Report: Drug-Related Emergency Department Visits Involving Pharmaceutical Misuse and Abuse by Older Adults. Available at: <http://archive.samhsa.gov/data/2k12/DAWN108/SR108PharmaAbuse2012.htm>. Accessed on: Feb 16, 2018.
- ²⁴ Colliver JD, Compton WM, Gfroerer JC, Condon T. Projecting Drug Use Among Aging Baby Boomers in 2020. *Annals of Epidemiology*. 2006; 16(4):257-265.
- ²⁵ Bogunovic O. Substance Abuse in Aging and Elderly Adults. July 12, 2012. Available at: <http://www.psychiatrytimes.com/geriatric-psychiatry/substance-abuse-aging-and-elderly-adults>. Accessed on: Feb 16, 2018.
- ²⁶ The Joint Commission. Pain Management. Available at: www.jointcommission.org/topics/pain_management.aspx. Accessed on: Feb 16, 2018.
- ²⁷ NIH National Center for Complementary and Integrative Health. Complimentary Health Approaches for Pain Management. September 2016. NCCIH Clinical Digest. Available at: <https://nccih.nih.gov/health/providers/digest/chronic-pain>. Accessed on: Mar 6, 2018.
- ²⁸ U.S. Department of Health and Human Services. Multiple Chronic Conditions: A Strategic Framework. Optimum Health and Quality of Life for Individuals with Multiple Chronic Conditions. Available at: www.hhs.gov/ash/initiatives/mcc/mcc_framework.pdf. Accessed on: Feb 16, 2018.
- ²⁹ Centers for Medicare and Medicaid Services. Chronic Conditions among Medicare Beneficiaries, Chartbook, 2012 Edition. Baltimore, MD. 2012. Available at: <https://www.cms.gov/Research-Statistics-Data-and-Systems/Statistics-Trends-and-Reports/Chronic-Conditions/Downloads/2012Chartbook.pdf>. Accessed on: Feb 16, 2018.
- ³⁰ U.S. Department of Health and Human Services. The Challenge of Managing Multiple Chronic Conditions. Available at: www.hhs.gov/ash/initiatives/mcc/article.html. Accessed on: Feb 16, 2018.
- ³¹ Barile JP, Thompson WW, Zack MM, Krahn GL, Horner-Johnson W, Bowen SE. Multiple Chronic Medical Conditions and Health-Related Quality of Life in Older Adults, 2004–2006. *Preventing Chronic Disease*. 2013;10:120282. DOI: <http://dx.doi.org/10.5888/pcd10.120282>.

-
- ³² Ellis BH, Shannon ED, Cox JK, Aiken L, Fowler BM. Chronic conditions: results of the Medicare Health Outcomes Survey, 1998-2000. *Health Care Financing Review*. 2004; 25(4):75-91.
- ³³ Wiener JM, Hanely RJ, Clark R. *Measuring the Activities of Daily Living: Comparisons Across National Surveys*. 1990. Available at: <http://aspe.hhs.gov/daltcp/reports/meacmpes.htm>. Accessed on: Feb 16, 2018.
- ³⁴ Lawton MP, Brody EM. Assessment of older people: self-maintaining and instrumental activities of daily living. *Physical Self-maintenance*. 1969.
- ³⁵ Graf C. The Lawton Instrumental Activities of Daily Living (IADL) Scale. *Try This: Best Practices in Nursing Care to Older Adults*. 2013; 23. The Hartford Institute for Geriatric Nursing, New York University, College of Nursing. Available at: <https://consultgeri.org/try-this/general-assessment/issue-23.pdf>. Accessed on: Feb 16, 2018.
- ³⁶ Walter LC, Brand RJ, Counsell SR, Palmer RM, Landefeld CS, Fortinsky RH, Covinsky KE. Development and Validation of a Prognostic Index for 1-Year Mortality in Older Adults After Hospitalization *JAMA*. 2001; 285(23):2987-2994.
- ³⁷ Newcomer R, Covinsky KE, Clay T, Yaffe K. Predicting 12-month mortality for persons with dementia. *The Journals of Gerontology, Series B, Psychological Sciences and Social Sciences*. 2003 May; 58(3):S187-98.
- ³⁸ Centers for Disease Control and Prevention. Health-Related Quality of Life (HRQOL) Concepts. Available at: www.cdc.gov/hrqol/concept.htm. Accessed on: Feb 16, 2018.
- ³⁹ Centers for Disease Control and Prevention. *Measuring Healthy Days: Population Assessment of Health-Related Quality of Life*. November 2000. Available at: www.cdc.gov/hrqol/pdfs/mhd.pdf. Accessed on: Feb 16, 2018.
- ⁴⁰ Centers for Disease Control and Prevention. *Overweight and Obesity*. Available at: www.cdc.gov/nccdphp/dnpa/obesity/index.htm. Accessed on: Feb 16, 2018.
- ⁴¹ Valdes AM, Andrew T, Gardner JP, Kimura M, Oelsner E, Cherkas LF, Aviv A, Spector TD. Obesity, cigarette smoking, and telomere length in women. *Lancet*. 2005; 366(9486):662-664. Available at: www.thelancet.com/journals/lancet/article/PIIS0140673605666305/abstract. Accessed on: Feb 16, 2018.
- ⁴² Hélène Choquet, and David Meyre. Genetics of Obesity: What have we Learned? *Current Genomics*. 2011 May; 12(3): 169–179. Available at: <https://www.ncbi.nlm.nih.gov/pmc/articles/PMC3137002/>. Accessed on: Feb 16, 2018.
- ⁴³ Krueger PM, Rogers RG, Hummer RA, Boardman JD. Body mass, smoking, and overall and cause-specific mortality among older U.S. adults. *Research on Aging*. 2004; 26(1):82-107.
- ⁴⁴ Federal Interagency Forum on Aging-Related Statistics. *Older Americans 2016: Key Indicators of Well-Being*. Washington, DC: U.S. Government Printing Office. Available at: <https://agingstats.gov/docs/LatestReport/OA2016.pdf>. Accessed on: Feb 16, 2018.
- ⁴⁵ Miller SL, Wolfe RR. The danger of weight loss in the elderly. *J Nutr Health Aging*. Aug-Sep 2008; 12(7):487-491.
- ⁴⁶ Sullivan PW, Ghushchyan V, Ben-Joseph RH. The Effect of Obesity and Cardiometabolic Risk Factors on Expenditures and Productivity in the United States. *Obesity*. 2008; 16 (9): 2155-2162.
- ⁴⁷ Sullivan PW, Ghushchyan VH, Ben-Joseph RH. The impact of obesity on diabetes, hyperlipidemia and hypertension in the United States. *Quality of Life Research*. 2008; 17 (8): 1063-1071.

-
- ⁴⁸ Backhaus J, Junghanns K, Broocks A, Riemann D, Hohagen F. Test-retest reliability and validity of the Pittsburgh Sleep Quality Index in primary insomnia. *Journal of Psychosomatic Research*. 2002; 53(3):737-40.
- ⁴⁹ Zisberg A, Gur-Yaish N, Shochat T. Contribution of routine to sleep quality in community elderly. *Sleep*. 2010; 33(4):509–514.
- ⁵⁰ Gangwisch JE, Malaspina D, Boden-Albala B, Heymsfield SB. Inadequate sleep as a risk factor for obesity: analyses of the NHANES I. *Sleep*. 2005; 28(10):1289-96.
- ⁵¹ Lauderdale DS, Knutson KL, Yan LL, Liu K, Rathouz PJ. Sleep duration: how well do self-reports reflect objective measures? The CARDIA Sleep Study. *Epidemiology*. 2008; 19(6):838–845.
- ⁵² Trivedi AN, Zaslavsky AM, Schneider EC, Ayanian JZ. Relationship between quality of care and racial disparities in Medicare health plans. *Journal of the American Medical Association*. 2006; 296(16):1998-2004.
- ⁵³ Virnig BA, Scholle SD, Chou AF, Shih S. Efforts to reduce racial disparities in Medicare managed care must consider the disproportionate effects of geography. *American Journal of Managed Care*. 2007; 13(1):51-56.
- ⁵⁴ Health Services Advisory Group. *Medicare Health Outcomes Survey: Report on the Health Status of Disadvantaged Medicare Beneficiaries*. 2005. Available at: http://hosonline.org/globalassets/hos-online/publications/disadvantaged_medicare_beneficiaries.pdf. Accessed on: Feb 16, 2018.
- ⁵⁵ Ng J, Scholle SH, Wong L, Kong V, Iruka N, Mierzejewski R. *Disparities in Medicare Beneficiary Outcomes: Sociodemographic Vulnerability and Prevalent Problems in Older Populations*. November 2007. Available at: http://hosonline.org/globalassets/hos-online/publications/hos_disparities_final_technical_report.pdf. Accessed on: Feb 16, 2018.
- ⁵⁶ CMS Office of Minority Health and HSAG. *Understanding the Health Needs of Diverse Groups of Asian and Native Hawaiian or Other Pacific Islander Medicare Beneficiaries*. Baltimore, MD. 2017. Available at: <http://www.hosonline.org/globalassets/hos-online/publications/cms-omh-data-highlight-vol10-aug-2017.pdf>. Accessed on: Mar 6, 2018.
- ⁵⁷ Agency for Healthcare Research and Quality. *Overview: Urinary Incontinence in Adults, Clinical Practice Guideline Update*. Rockville, MD; 1996. Available at: <http://archive.ahrq.gov/clinic/uioverview.htm>. Accessed on: Feb 16, 2018.
- ⁵⁸ Fultz NH, Herzog AR. Self-reported social and emotional impact of urinary incontinence. *Journal of American Geriatrics Society*. 2001; 49:892-899.
- ⁵⁹ Peters TJ, Horrocks S, Stoddart H, Somerset M. Factors associated with variations in older people's use of community-based continence services. *Health & Social Care in the Community*. 2004; 12:53-62.
- ⁶⁰ Mardon RE, Halim S, Pawlson G, Haffer SC. Management of urinary incontinence in Medicare managed care beneficiaries. *Archives of Internal Medicine*. 2006; 166:1128-1133.
- ⁶¹ Subak LL, Quesenberry CP, Posner SF, Cattolica E, Soghikian K. The effect of behavioral therapy on urinary incontinence: a randomized controlled trial. *Obstetrics & Gynecology*. 2003; 100:72-78.
- ⁶² Shamliyan T, Wyman J, Kane RL. Nonsurgical Treatments for Urinary Incontinence in Adult Women: Diagnosis and Comparative Effectiveness. *Comparative Effectiveness Reviews*. April 2009; 11(12): EHC074-EF.
- ⁶³ Centers for Disease Control and Prevention. *Healthy Aging: Improving and Extending Quality of Life Among Older Americans At a Glance, 2010*. Available at: <http://www.cdc.gov/chronicdisease/resources/publications/aag/pdf/2015/healthy-aging-aag.pdf>. Accessed on: Feb 16, 2018.

-
- ⁶⁴ Hubbard RE, Fallah N, Searle SD, Mitnitski A, Rockwood K. Impact of exercise in community-dwelling older adults. *Public Library of Science (PLoS ONE)*. 2009; Volume:4 Issue:7 Article Number: e6174.
- ⁶⁵ Tager IB, Haight T, Sternfeld B, Yu Z, van Der Laan M. Effects of physical activity and body composition on functional limitation in the elderly: Application of the marginal structural model. *Epidemiology*. 2004; 15(4): 479-493.
- ⁶⁶ U.S. Department of Health and Human Services. *Physical Activity and Health: A Report of the Surgeon General*. Atlanta, GA: Centers for Disease Control and Prevention (CDC), National Center for Chronic Disease Prevention and Health Promotion, 1996. Available at: www.cdc.gov/nccdphp/sgr/sgr.htm. Accessed on: Feb 16, 2018.
- ⁶⁷ Finkelstein EA, Trogon JG, Cohen JW, Dietz W. Annual Medical Spending Attributable To Obesity: Payer-And Service-Specific Estimates. *Health Affairs*. 2009; 28(5):w822-w831 (published online July 27, 2009). Available at: <http://content.healthaffairs.org/content/28/5/w822.full.html>. Accessed on: Feb 16, 2018.
- ⁶⁸ Agency for Healthcare Research and Quality, and the Centers for Disease Control. *Physical Activity and Older Americans: Benefits and Strategies*. 2002. Available at: <https://innovations.ahrq.gov/qualitytools/physical-activity-and-older-americans-benefits-and-strategies>. Accessed on: Feb 16, 2018.
- ⁶⁹ Rogers CE, Larkey LK, Keller C. A review of clinical trials of tai chi and qigong in older adults. *Western Journal of Nursing Research*. 2009; 31(2): 245-279.
- ⁷⁰ Elavsky S, McAuley E, Motl RW, Konopack JF, Marquez DX, Hu L, Jerome GJ, Diener D. Physical activity enhances long-term quality of life in older adults: efficacy, esteem, and affective influences. *Annals of Behavioral Medicine*. 2005; 30(2):138-145.
- ⁷¹ U.S. Department of Health and Human Services, Centers for Disease Control and Prevention. *A Report of the Surgeon General. Physical Activity and Health: Older Adults*. Available at: www.cdc.gov/nccdphp/sgr/pdf/olderad.pdf. Accessed on: Feb 16, 2018.
- ⁷² Wise LA, Adams-Campbell LL, Palmer JR, Rosenberg L. Leisure time physical activity in relation to depressive symptoms in the Black Women's Health Study. *Annals of Behavioral Medicine*. 2006; 32(1):68-76.
- ⁷³ U.S. Department of Health and Human Services. *Healthy People 2010, 2nd Edition*. With Understanding and Improving Health and Objectives for Improving Health. 2 Vols. Washington, DC: U.S. Government Printing Office, November 2000.
- ⁷⁴ US Department of Health & Human Services (HHS). Office of Disease Prevention and Health Promotion. 2008 Physical Activity Guidelines for Americans. Washington: HHS; 2008. Available at: www.health.gov/paguidelines/guidelines. Accessed on: Feb 16, 2018.
- ⁷⁵ US Department of Health & Human Services. Healthy People 2020: Physical Activity Objectives. Available at: <https://www.healthypeople.gov/2020/topics-objectives/topic/physical-activity/objectives>. Accessed on: Feb 16, 2018.
- ⁷⁶ U.S. Preventive Services Task Force. *Guide to Clinical Preventive Services, 2nd Edition*. Washington, DC: Office of Disease Prevention and Health Promotion; 1996:611-624.
- ⁷⁷ Centers for Disease Control and Prevention, Prevention Research Centers-University of Washington *PRC Intervention Wins National Award*. Available at: https://www.cdc.gov/prc/pdf/prc_enhancefitness_story.pdf. Accessed on: Feb 16, 2018.

-
- ⁷⁸ Centers for Disease Control and Prevention. National Center for Injury Prevention and Control. *Falls Among Older Adults: An Overview*. Available at: <http://www.cdc.gov/HomeandRecreationalSafety/Falls/adultfalls.html>. Accessed on: Feb 16, 2018.
- ⁷⁹ Stevens JA, Corso PS, Finkelstein EA, Miller TR. The costs of fatal and nonfatal falls among older adults. *Injury Prevention*. 2006; 12:290-5.
- ⁸⁰ Marika JS, Tero JV, Maritta TS, Pertti TTA, Sirkka-Liisa K. Effect of a risk-based multifactorial fall prevention program on the incidence of falls. *Journal of American Geriatrics Society*. 2009; 57:612-619.
- ⁸¹ Centers for Disease Control and Prevention. Self reported falls and fall-related injuries among persons aged ≥ 65 years - United States, 2006. *Morbidity and Mortality Weekly Report*. 2008; 57(9):225-6. Available at: www.cdc.gov/mmwr/preview/mmwrhtml/mm5709a1.htm. Accessed on: Feb 16, 2018.
- ⁸² Tinetti ME, Williams CS. Falls, injuries due to falls, and the risk of admission to a nursing home. *New England Journal of Medicine*. 1997; 337:1279-1284.
- ⁸³ Centers for Disease Control and Prevention, National Center for Injury Prevention and Control. *Web-based Injury Statistics Query and Reporting System (WISQARS)*. Available at: <http://www.cdc.gov/injury/wisqars/facts.html>. Accessed on: Feb 16, 2018.
- ⁸⁴ Stevens JA, Corso PS, Finkelstein EA, Miller TR. The costs of fatal and nonfatal falls among older adults. *Injury Prevention* 2006a; 12:290-5.
- ⁸⁵ Brooke-Wavell K, Perrett LK, Howarth PA, Howarth RA. Influence of the visual environment on the postural stability in healthy older women. *Gerontology*. 2002; 48:293-297.
- ⁸⁶ Centers for Disease Control and Prevention. National Center for Injury Prevention and Control. *Costs of Falls Among Older Adults*. Available at: <http://www.cdc.gov/HomeandRecreationalSafety/Falls/fallcost.html>. Accessed on: Feb 16, 2018.
- ⁸⁷ Stevens JA, Sogolow ED. Gender differences for non-fatal unintentional fall related injuries among older adults. *Injury Prevention*. 2005; 11:115-9.
- ⁸⁸ Wagner EH, LaCroix AZ, Grothaus L, Leveille SD, Hecht JA, Artz K, Odle K, Buchner DM. Preventing disability and falls in older adults: A population-based randomized trial. *American Journal of Public Health*. 1994; 84:1800-1806.
- ⁸⁹ Wyman JF, Croghan CF, Nachreiner NM, Gross CR, Stock HH, Talley K, Manigold M. Effectiveness of education and individualized counseling in reducing environmental hazards in the homes of community-dwelling older women. *Journal of American Geriatric Society*. 2007; 55(10):1548-56.
- ⁹⁰ The Joint Commission. *Improving and Measuring Osteoporosis Management*. Oakbrook Terrace, IL: The Joint Commission; 2007.
- ⁹¹ World Health Organization. *Assessment of Fracture Risk and its Application to Screening for Postmenopausal Osteoporosis*. No. 843 of Technical Report series. Geneva: The Organization. 1994.
- ⁹² *Osteoporosis Prevention, Diagnosis, and Therapy*. NIH Consensus Statement Online 2000 March 27-29; 17(1):1-36. Available at: <https://consensus.nih.gov/2000/2000Osteoporosis111PDF.pdf>. Accessed on: Feb 16, 2018.
- ⁹³ U.S. Department of Health and Human Services. *Bone Health and Osteoporosis: A Report of the Surgeon General*. U.S. Department of Health and Human Services, Office of the Surgeon General. 2004. Available at: <http://www.ncbi.nlm.nih.gov/books/NBK45513>. Accessed on: Feb 16, 2018.
- ⁹⁴ Gass M, Dawson-Hughes B. Preventing osteoporosis-related fractures: an overview. *The American Journal of Medicine*. 2006; 119(4 Suppl 1):S3-S11.

-
- ⁹⁵ Scientific Advisory Board, Osteoporosis Society of Canada. Clinical practice guidelines for the diagnosis and management of osteoporosis. *Journal of the Canadian Medical Association*. 1996; 155(8):1113-1133.
- ⁹⁶ Nelson HD, Helfand M, Woolf SH, Allan JD. Screening for postmenopausal osteoporosis: A review of the evidence for the U.S. Preventive Services Task Force. *Annals of Internal Medicine*. 2002; 137(6):529-541.
- ⁹⁷ National Osteoporosis Foundation. *Learn about Osteoporosis*. Available at: <https://www.nof.org/preventing-fractures/>. Feb 16, 2018.
- ⁹⁸ Delaney MF. Strategies for the prevention and treatment of osteoporosis during early postmenopause. *American Journal of Obstetrics and Gynecology*. 2006; 194(2 Suppl):S12-23.
- ⁹⁹ Bonaiuti D, Shea B, Iovine R, Negrini S, Robinson V, Kemper HC, Wells G, Tugwell P, Cranney A. Exercise for preventing and treating osteoporosis in postmenopausal women. *Evidence Based Nursing*. 2003; 6(2):50-1.
- ¹⁰⁰ Iqbal SU, Rogers W, Selim A, Qian S, Lee A, Ren XS, Rothendler J, Miller D, Kazis L. The Veterans RAND 12 Item Health Survey (VR-12): What it is and How it is Used. 2007. Available at: http://hosonline.org/globalassets/hos-online/publications/veterans_rand_12_item_health_survey_vr-12_2007.pdf. Accessed on: Feb 16, 2018.
- ¹⁰¹ Kazis LE, Selim A, Rogers W, Ren XS, Lee A, Miller DR. Dissemination of methods and results from the Veterans Health Study: final comments and implications for future monitoring strategies within and outside the Veterans Health Care System. *Journal of Ambulatory Care Management*. 2006; 29(4):310-319.
- ¹⁰² Kazis LE, Miller DR, Skinner KM, Lee A, Ren XS, Clark JA, Rogers WH, Spiro III A, Selim A, Linzer M, Payne SM, Mansell D, Fincke BG. Applications of methodologies of the Veterans Health Study in the VA Health Care System: conclusions and summary. *Journal of Ambulatory Care Management*. 2006; 29(2):182-188.
- ¹⁰³ Boston University School of Public Health. VR-36, VR-12 and VR-6D Overview. Available at: <http://www.bu.edu/sph/research/research-landing-page/vr-36-vr-12-and-vr-6d/>. Accessed on: Feb 16, 2018.
- ¹⁰⁴ Jones D, Kazis LE, Lee A, Rogers W, Skinner K, Cassar L, Wilson N, Hendricks A. Health status assessments using the Veterans SF-36 and SF-12: Methods for evaluating outcomes in the Veterans Health Administration. *Journal of Ambulatory Care Management*. 2001; 24(3):1-19.
- ¹⁰⁵ Kazis LE, Lee A, Spiro III A, Rogers W, Ren XS, Miller DR, Selim A, Hamed A, Haffer SC. Measurement comparisons of the Medical Outcomes Study and the Veterans SF-36 Health Survey. *Health Care Financing Review*. 2004; 25(4):43-58.
- ¹⁰⁶ Kazis LE, Miller DR, Clark JA, Skinner KM, Lee A, Ren XS, Spiro III A, Rogers WH, Ware Jr JE. Improving the response choices on the Veterans SF-36 Health Survey role functioning scales: results from the Veterans Health Study. *Journal of Ambulatory Care Management*. 2004; 27(3):263-280.
- ¹⁰⁷ Spiro A, Rogers WH, Qian S, Kazis LE. *Imputing physical and mental summary scores (PCS and MCS) for the Veterans SF-12 Health Survey in the context of missing data*. Technical Report prepared by: The Health Outcomes Technologies Program, Health Services Department, Boston University School of Public Health, Boston, MA and The Institute for Health Outcomes and Policy, Center for Health Quality, Outcomes and Economic Research, Veterans Affairs Medical Center, Bedford, MA. 2004. Available at: http://hosonline.org/globalassets/hos-online/publications/hos_veterans_12_imputation.pdf. Accessed on: Feb 16, 2018.

-
- ¹⁰⁸ Perlin J, Kazis LE, Skinner K, Ren XS, Lee A, Rogers WH, Spiro A, Selim A, Miller D. Health status and outcomes of veterans: physical and mental component summary scores, Veterans SF-36, 1999 Large Health Survey of Veteran Enrollees. Executive Report. *Department of Veterans Affairs, Veterans Health Administration, Office of Quality and Performance*. Washington, DC. 2000.
- ¹⁰⁹ Selim A, Iqbal SU, Rogers W, Qian SX, Fincke BG, Rothender J, Kazis LE. *Medicare Health Outcomes Survey: An Alternative Case-Mix Methodology*. Technical Report prepared by: Center for Health Quality, Outcomes, and Economic Research, VA Medical Center, Bedford, MA. 2007. Available at: http://hosonline.org/globalassets/hos-online/publications/hos_case_mix_final_technical_report.pdf. Accessed on: Feb 16, 2018.
- ¹¹⁰ Rogers WH, Gandek B, Sinclair SJ. *Calculating Medicare Health Outcomes Survey Performance Measurement Results*. Technical Report prepared by: Health Assessment Lab, Waltham, MA, The Health Institute, Department of Clinical Care Research, New England Medical Center, Boston, MA. 2004. Available at: http://hosonline.org/globalassets/hos-online/publications/hos_calculating_pm_results.pdf. Accessed on: Feb 16, 2018.